



# SUSTAINABILITY GUIDE FOR OLDER AND HISTORIC BUILDINGS



DC HISTORIC PRESERVATION REVIEW BOARD







# TABLE OF CONTENTS

<b>I. INTRODUCTION</b>	<b>1</b>
How to Use This Guide	
Existing Buildings and Energy Consumption	
Sustainability and Historic Preservation	
Inherently Sustainable Building Features	
<b>II. PLANNING A GREEN RETROFIT</b>	<b>9</b>
Know Your Building	
Evaluate Current Performance	
Optimize Current Performance	
Define Your Goals	
Develop a Coordinated Plan	
Maintain and Monitor Performance	
<b>III. GREEN RETROFIT STRATEGIES</b>	<b>19</b>
Walls and Roofs	
Windows and Doors	
Solar and Green Roof Installations	
Landscape and Site Features	
<b>IV. HISTORIC PRESERVATION REVIEW</b>	<b>51</b>
<b>V. DC BUILDING CODES AND CODE CONSIDERATIONS</b>	<b>57</b>
<b>VI. ADDITIONAL RESOURCES</b>	<b>61</b>



# I. INTRODUCTION

The District of Columbia contains a rich collection of older buildings that help define the character of our neighborhoods and establish a valued sense of place. Conserving that character is a cornerstone of the District’s planning policies, enacted primarily through the District’s historic preservation law. The law establishes a preservation review process to ensure that historic properties are retained and enhanced, to ensure that changes are compatible with the character of designated buildings, and to encourage the adaptation of historic property for current use.

The District is also committed to being a national leader in green building and sustainability practices. The city’s ambitious environmental policies aim to make Washington the healthiest, greenest, and most livable city in the country by enhancing our sustainability in a manner that is environmentally, economically, and socially just. In order to achieve this goal, the Sustainable DC 2.0 Plan (2019) and Clean Energy DC Plan (2018), outline high-performance targets and actions including a major reduction in energy use and greenhouse gas emissions, an increase in renewable energy sources, net-zero energy standards for new construction and existing multifamily and commercial buildings, and a decrease in total water usage. The Clean Energy DC Omnibus Amendment Act of 2018 codified some of the most important actions, including a 100 percent Renewable Energy Portfolio Standard (RPS) and energy efficiency mandates.

The District’s historic resources number over 700 landmarks and almost 70 historic districts listed in the DC Inventory of Historic Sites and the National Register of Historic Places. Beyond these recognized landmarks and districts, a majority of the city’s existing building stock—approximately 72% —was constructed before 1945. Improving the performance of the District’s older building stock through green retrofits is a fundamental component of the Sustainable DC Plan. This guideline is intended to promote and facilitate green retrofits of existing older buildings in a manner that will improve their performance and energy-efficiency while also being respectful of their character. Performance improvement of these buildings provides the opportunity to continue the financial and environmental amortization of the investments made in the initial construction of these structures.



# HOW TO USE THIS GUIDE

This guide is an introduction to the systematic sequence of evaluation, planning and decision-making required to carry out an effective green retrofit for owners, tenants, managers, and residents of older and historic buildings. While oriented primarily to pre-1945 small-scale buildings, the methodology for evaluating and planning can also be applied to other building types.

Six steps are outlined in Section II to help you evaluate your existing building and current energy performance, and to define your project goals and develop a coordinated plan for making improvements.

A variety of green retrofit strategies are discussed in Section III, organized by building components and by lower and higher cost strategies that property owners can consider. This section also provides design principles for achieving compatible alterations for green retrofits on historic properties. These guidelines reflect considerations that are applied in the review of alterations, including:

**Visibility or prominence from the street:** Changes that are visible to the public are more likely to affect a historic property's character. As a rule, alterations on primary elevations prominently visible from a street should be more carefully considered, while greater flexibility is warranted for changes on secondary elevations that are minimally visible or not visible at all.

**Level of property significance:** Historic properties may merit different levels of treatment depending on their relative significance. Buildings of greater architectural or historical character may warrant more careful treatment. Changes to properties in historic districts are reviewed in the context of their relative significance to the district.

**Contextual and compatible design:** The design of features for historic properties should display an awareness of and response to the specific character defining qualities of the property. The new work shall be differentiated from the old and shall be compatible with the massing, size, scale, and architectural features to protect the historic integrity of the property and its environment.

**Quality of design and materials:** Historic buildings may display a high quality of design and materials which should be retained. Special features that are custom designed or crafted, or that represent an unusual degree of styling or detailing warrant care and all reasonable efforts should be made to preserve or replicate them accurately. A more flexible standard may be applied to elements that were mass-produced, do not have distinguishing characteristics or that are easily replicable.

**Temporary and additive change vs. permanent and destructive change:** Alterations that are temporary or easily reversible with a minimized degree of demolition to the existing building have less of a lasting impact on the character of a historic property than changes that permanently change, damage, or remove important features.

**Achieving a reasonable balance:** Adapting old buildings requires a thoughtful consideration of practical needs along with the environmental and civic benefits of protecting architectural and historical characteristics valued by the community.

For older buildings that are designated as landmarks or located within historic districts, information on the preservation review process is provided in Section IV. A discussion of DC Construction and Green Codes is provided in Section V, and additional sources for more in-depth information is provided in Section VI.

# EXISTING BUILDINGS AND ENERGY CONSUMPTION

Buildings are the primary source of energy use, resource consumption, and greenhouse gas (GHG) emissions. In the District, as of 2016, residential and commercial buildings accounted for 73% of total energy consumption. The city's success at reducing emissions depends on reducing its energy use and reliance on fossil fuels by improving the performance of existing buildings and expanding renewable energy sources.

Recent changes to local law and building codes mandate green building requirements in new construction, larger renovations, as well as projects on District-owned buildings. In addition, the District of Columbia recently passed a law that requires electricity to be provided from 100% renewable energy sources by 2032 and mandates that existing buildings greater than 50,000 sf must meet energy efficiency standards starting in 2021 with that threshold dropping to 10,000 sf in 2026. Adoption of a net-zero energy building code—one that shifts away from fossil fuels—is expected in the District by 2026 for commercial new construction and 2022 for residential.

The federal government has also implemented a major push to improve performance of federally-owned buildings, including installation of solar energy systems on buildings within the District.

Retrofitting existing older buildings in the District yields the following positive outcomes:

- meaningful environmental benefits due to lowered energy use and less GHG emissions;
- reduced energy costs for the owner;
- improved thermal comfort and quieter, more efficient systems for building occupants;
- protection of the city's older buildings—via this conscientious maintenance—which preserves the unique character of buildings and neighborhoods.

**Sustainability** is defined as meeting the economic, social, and environmental needs of today while ensuring future generations will also be able to meet their own needs.

**Green Retrofits** are any type of upgrade to an existing building intended to improve energy and environmental performance, reduce water usage, and improve the comfort and quality of the space in terms of natural light, air quality, and noise.

### 2015 ESTIMATED PROPORTION OF SITE ENERGY USE BY SECTOR

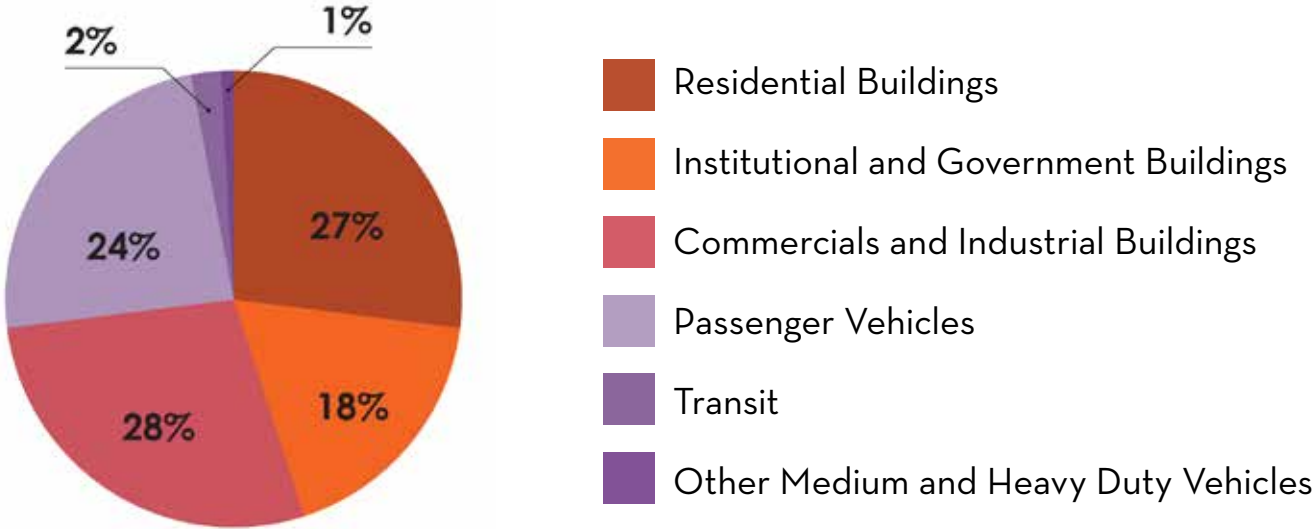

SOURCE: CLEAN ENERGY DC

### 2015 RESIDENTIAL ELECTRICITY CONSUMPTION BY END USE

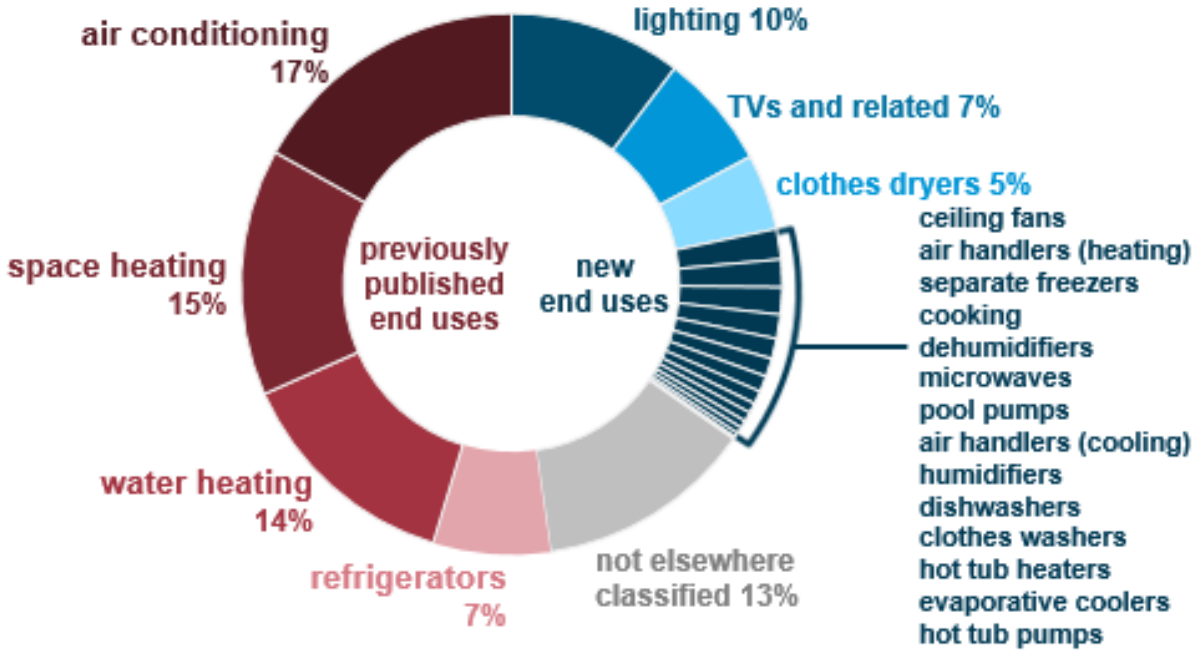

SOURCE: ENERGY INFORMATION ADMINISTRATION

# SUSTAINABILITY AND HISTORIC PRESERVATION

There is a common misconception that the principles of sustainability and green building design are at odds with those of historic preservation. Quite the opposite is true: historic buildings offer effective solutions to save energy and continued use of buildings and materials with an existing carbon footprint within their manufacture and installation reduces new environmental effects as well as amortizing the past impacts. Additionally, building systems and components, like HVAC or lighting, that do not contribute to the historic character of a building can be updated without triggering historic review at all. Maintaining existing buildings and improving their energy performance will help the District meet its sustainability goals as the District, like any major city, cannot build its way out of these impacts.

## THE GREENEST BUILDING

By preserving and retrofitting historic and older buildings, we reduce waste, maximize the use and life of materials and preserve the historic character of our city and neighborhoods. A 2011 study conducted by the National Trust for Historic Preservation found that continuing the life of existing buildings typically offers benefits over demolition and new construction. Due to the negative environmental impacts caused by the construction process, the study finds that it takes between 10-80 years for a new building to overcome the negative climate change impacts related to the construction process. Renovation and reuse of existing buildings of comparable functionality and size almost always yield fewer environmental impacts than demolition and new construction over a 75-year period, when comparing buildings with equivalent energy efficiency levels.

In addition, older buildings have been found to be more energy-efficient than more recently constructed buildings. The Energy Information Administration (EIA) has documented that older commercial buildings generally use less energy per square foot and perform better than those built between 1920 and 2000. These older buildings were constructed in an era without climate control technology. As a result, they used architectural means to keep the interior environment cool in the summer and warm in the winter. Because these structures are not as dependent on mechanical systems, they are more efficient and equipped to function without consuming as much energy as their modern counterparts. This does not hold true for buildings constructed after World War II when the interior environment became more reliant on mechanical systems.

Inherently sustainable and energy-efficient building features were designed out of necessity in older buildings in response to local climate conditions. These traditional strategies maximized natural sources of light, ventilation, and heating. Some of the most common features found in District buildings include:

- thick walls and party wall construction;
- operable windows, transoms;
- attic vents, dormers, and high ceilings;
- shutters and awnings;
- landscaping and site features.





1347 MAPLE VIEW PLACE SE, BUILT 1894, RESTORED IN 2013

# INHERENTLY SUSTAINABLE BUILDING FEATURES

The following design features were often used in older buildings to provide passive heating, cooling, and lighting, and to improve interior comfort of buildings. These features should be maintained where they exist, and can be designed and applied in green retrofits and new design, where appropriate, to improve efficiency and performance.

## LANDSCAPING & WATER EFFICIENCY

**Landscaping** – Trees and other landscaping improve interior conditions and minimize energy use by providing sun shade and wind deflection. For instance, deciduous trees can shade a house from intense sun in the summer but allow more desirable winter sun after leaves have fallen. Evergreen trees, particularly those planted on the north side of a building, can be an effective windbreak.

**Permeable Surfaces** – Vegetative and pervious paving help absorb water and reduce flash flooding.

**Water Efficiency** – Above and below ground cisterns or reservoirs can capture and store rainwater for future use.

## DAYLIGHTING & VENTILATION

**Windows** – Operable windows provide and control daylight and natural ventilation, reducing dependence on mechanical systems and artificial lighting.

The location and size of window openings is often determined in response to the building's orientation to the sun and local climate to help control heat gain and facilitate ventilation. For instance, larger windows and glass transoms carry light and air deep into a building while smaller windows will help reduce sun exposure and heat gain.

Skylights, light wells for basement windows, roof monitors, dormers, and transoms all enhance daylighting within interior spaces.

**Shutters** – Shutters, when functional, reduce heat loss or gain through windows and are beneficial for cooling and protecting the interior from the elements. If compatible, shutters may be placed on the exterior or interior of a building, and may be solid or have louvers that allow some light and air flow.

**Attic Vents** – Attic vents and dormer windows help circulate air, keeping a building cool and reducing moisture build-up. Dormers can also improve the functionality of attic spaces by allowing light and ventilation and increasing space.



THESE DECIDUOUS STREET TREES PROVIDE SHADE FOR PEDESTRIANS AND ADJACENT BUILDINGS IN THE SUMMER, BUT ALLOW MORE SUN IN THE WINTER.

*Library of Congress*



TRANSOMS LIKE THE ONES ON THIS STOREFRONT, IMPROVE NATURAL LIGHTING AND VENTILATION ON THE INTERIOR.

*Library of Congress*



OPERABLE SHUTTERS PROVIDE SHADING WHEN NEEDED, IMPROVING THERMAL PERFORMANCE OF WINDOWS, AS WELL AS PRIVACY AND STORM PROTECTION.

*Library of Congress*



**Storm Windows** – Storm windows provide additional insulation, reduce noise and drafts, and improve the general performance and durability of existing windows. Interior storm windows offer ease of maintenance and have a lesser impact to the exterior of a historic building.

**Screens** – Screens can replace storm windows in the summer to permit fresh air flow while protecting the interior from elements, debris, animals and insects while windows are open.

**Awnings** – Awnings provide shade and help keep a building cool. On commercial buildings, awnings protect pedestrians from elements and provide shading for large show windows to keep interiors cool and protect merchandise.

**Porches** – Porches provide sheltered outdoor living space, take advantage of winds to maximize cross ventilation, and shade exterior walls and windows from the sun.

## DESIGN & MATERIALS

**Siting & Orientation** – Building design and layout is generally influenced by specific site conditions and orientation to the sun in order to control and enhance natural daylighting and passive ventilation and climate control.

**Party Walls** – Rowhouses have shared party walls (common walls between the adjoining buildings) and thus limited outside exposure, which helps to reduce heat gains and losses.

**Durability & Repairability** – Many old and durable building materials were locally produced, and have long lifespans. The ability to repair building components and assemblies contributes to longer lifespans. For instance, damaged shingles on a slate roof can be repaired individually rather than requiring a complete roof replacement. Likewise, parts of a wood window assembly can be repaired if damage occurs or if a glass pane breaks, requiring less waste and expense. Partial replacements allow for the continued amortization of the initial expense investment and heritage value.

**Masonry** – Thick masonry walls, common in the District, have high thermal mass and resulting thermal lag, which helps moderate interior temperatures, keeping buildings cooler in the summer and warmer in the winter.

**High Ceilings** – High ceilings increase daylighting in a space and improve air flow. They allow warmer air to rise to the ceiling, cooling the room allowing the occupied lower areas to be cooler.



AWNINGS ON THESE DOWNTOWN BUILDINGS PROVIDE SHADE FOR PEDESTRIANS, LARGE STOREFRONT WINDOWS AND UPPER STORIES.  
*Library of Congress*



PORCHES PROVIDE SHELTERED OUTDOOR LIVING SPACE, MAXIMIZE CROSS VENTILATION, AND SHADE EXTERIOR WALLS AND WINDOWS.  
*Library of Congress*



THESE ROWHOUSES HAVE PORCHES, SHUTTERS, AND MASONRY WALLS, ALL OF WHICH IMPROVE PERFORMANCE AND ENERGY-EFFICIENCY.  
*Library of Congress*

## II. PLANNING A GREEN RETROFIT

Sustainability and green retrofits are about more than just new technology and gadgets. To deal with the bigger picture—reducing environmental impacts through a reduction in consumption, waste, and emissions—the retrofit planning effort for existing older buildings should take a holistic and comprehensive approach.

Successful approaches consider how different building systems, components and features function and are connected, and specifically tailor a retrofit plan and strategies to a building’s individual characteristics. It should also balance the goals of sustainability and green design, constraints of an existing older building, and the preservation of historic character. A holistic approach is also the most cost-effective, as individual and uncoordinated efforts will only provide limited benefits and may ultimately require greater expense when additional repairs or upgrades are needed.

The following steps should be consulted before and throughout the retrofit process:

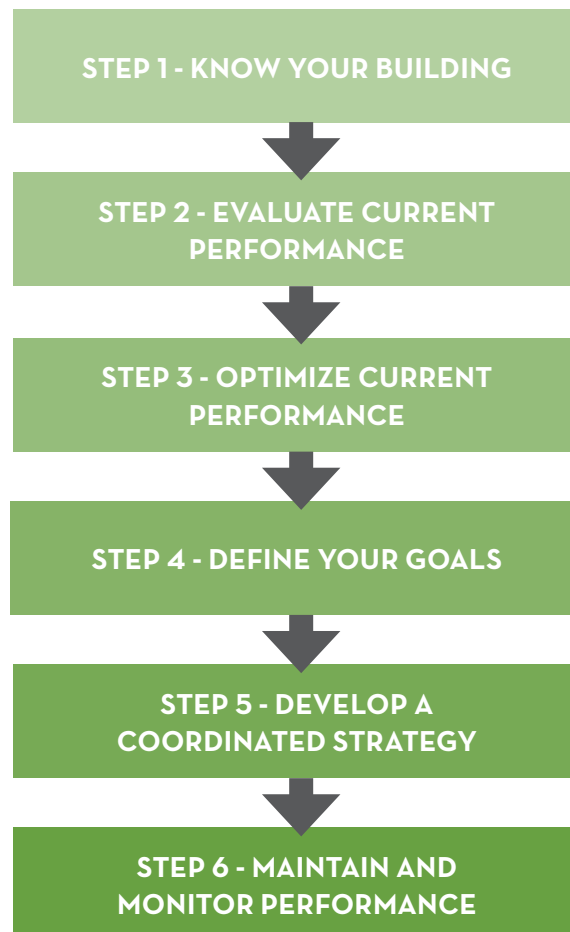



# STEP 1: KNOW YOUR BUILDING

Before initiating a green retrofit, it is crucial to gain a better understanding of your building, its history and evolution over time, its relationship with its surroundings and neighboring buildings, its physical aspects such as its materials and assemblies, its character-defining features, and its systems and operating functions. Answering these questions will help you determine needs, project goals, and the best strategies to incorporate as part of the retrofit.

BUILDING CHARACTERISTICS	1. <i>Building Type and Use</i>	<p>Is the building use residential (owner-occupied or rental), mixed-use, or commercial?</p> <p>If residential, is it single-family or multi-family?</p> <p>If commercial or mixed-use, is it occupied by a retail store, restaurant, or office?</p> <p>The type of building, its use, and activities will play a large role in the type and amount of energy used and as a result, the best strategies to utilize.</p>
	2. <i>Location and Orientation</i>	<p>How is the building oriented towards the sun?</p> <p>Where is it located on the block or in relationship to its neighbors? Is it detached, semi-detached, part of a row?</p> <p>Location and orientation can influence a property’s visibility, sun exposure, shading, potential moisture issues, and more.</p>
	3. <i>Construction</i>	<p>When was the building constructed and what are its primary materials?</p> <p>The most common building materials on older existing buildings in the District include brick, stone, concrete and wood. Different materials and construction methods will require different retrofit and upgrade strategies to reach the same energy efficiency levels.</p> <p>How many stories is the building? Does it have a basement or an attic? What is the roof shape and structure?</p> <p>Are there any noticeable alterations?</p> <p>Alterations may help you identify areas of flexibility or any areas that may need attention during the retrofit.</p> <p>What type of windows does the building have? Is the material wood, steel, or aluminum? How do they function? Are they double-hung, casement, fixed, or other?</p> <p>Different window materials and types may lend themselves to different retrofit strategies.</p>

BUILDING CHARACTERISTICS	4. <i>Character-Defining Features</i>	<p>What are the unique character-defining features on the building?</p> <p>Regardless of whether or not a building is designated historic, older existing buildings may contribute to the character and diversity of the District’s neighborhoods.</p> <p>Character is defined by the elements (known as the <i>character-defining features</i>) that make a building unique or special, including the distinctive materials, features and spaces, architectural styling or design, and unique construction methods or craftsmanship.</p> <p>Character-defining features should be identified during the planning phase and preserved when implementing strategies.</p>
	5. <i>Inherently Sustainable Features</i>	<p>What passive systems and inherently sustainable features exist on your building and what condition are they in? Are there passive systems that could be integrated into the retrofit?</p> <p>Inherently sustainable features should be identified and incorporated into your overall plan so that they work in cooperation with other strategies utilized. Maintaining and using these efficient features will improve sustainability and reduce unnecessary waste.</p>
	6. <i>Existing Systems</i>	<p>How do you heat and cool your building? Forced hot air, water pipes, steam pipes?</p> <p>Are existing systems operating effectively?</p> <p>Are there inherently sustainable features that you can take advantage of for passive heating and cooling?</p>
REGULATORY REQUIREMENTS AND LANDMARK STATUS	7. <i>Historic Designation Status</i>	<p>Is the building a landmark or located within a historic district listed in the DC Inventory of Historic Sites or National Register of Historic Places?</p> <p>You can find out by searching for your property on the Office of Planning PropertyQuest database, accessible here:  <a href="http://propertyquest.dc.gov/">http://propertyquest.dc.gov/</a></p> <p>Historic landmarks and buildings within historic districts require review by the Historic Preservation Office to ensure that alterations and green retrofit strategies do not negatively impact the historic character.</p>



## STEP 2: EVALUATE CURRENT PERFORMANCE

Evaluating the current performance of your building envelope and systems will identify deficiencies and help determine retrofit priorities and goals. The evaluation will provide an understanding of how the building is operating and will help to identify improper equipment performance, what equipment or systems need to be rehabilitated, retrofitted, or replaced, opportunities for saving energy and money, and strategies for improving performance of the various building systems.

Below are some methods commonly used to assess building performance. Most of these should be performed and analyzed by a professional energy auditor or building professional who follows a standard methodology, such as those developed by the Building Performance Institute.

### A. Energy Audit

- » Utility bill analysis is a low-cost method used to identify unusual operation or functioning, such as high fuel use in one season compared to the previous year. This analysis can also be used to establish consumption baselines to identify goals and strategies for reducing consumption and target inefficient systems.

### B. Blower Door Test

- » Unwanted air infiltration/leakage can be a large source of energy loss. Measuring the air tightness of a building can be performed by a blower door test, typically done by placing a large fan in a door opening and shutting all other exterior openings. The fan can be used to positively or negatively pressurize the building (either by blowing air into or sucking air out of the building) to identify and measure air leakage locations.



BLOWER TEST

### C. Thermal Imaging

- » Thermal imaging or infrared (IR) surveys can be performed on the exterior or interior of a building, and are used to determine locations of air leakage or inadequate thermal insulation. Addressing these locations of inadequate insulation and/or air infiltration or leakage is a productive first step in a home energy retrofit.

### D. Energy Modeling and Thermal Analysis

- » Computer software programs can provide an in-depth or whole-building energy analysis of a building or a single building component. Many new construction projects include a whole-building energy analysis, which provides a view of how each system can impact the efficiency of a building (e.g., whether more insulation or better windows will satisfy energy code requirements, and potentially be more effective in keeping future energy costs low). In addition to whole-building modeling, thermal analysis programs (such as WUFI or Therm) can provide a closer look at an individual building component. For instance, programs can evaluate a window or wall in order to determine the potential for condensation, how much insulation is required, or if/where a vapor barrier should be installed.

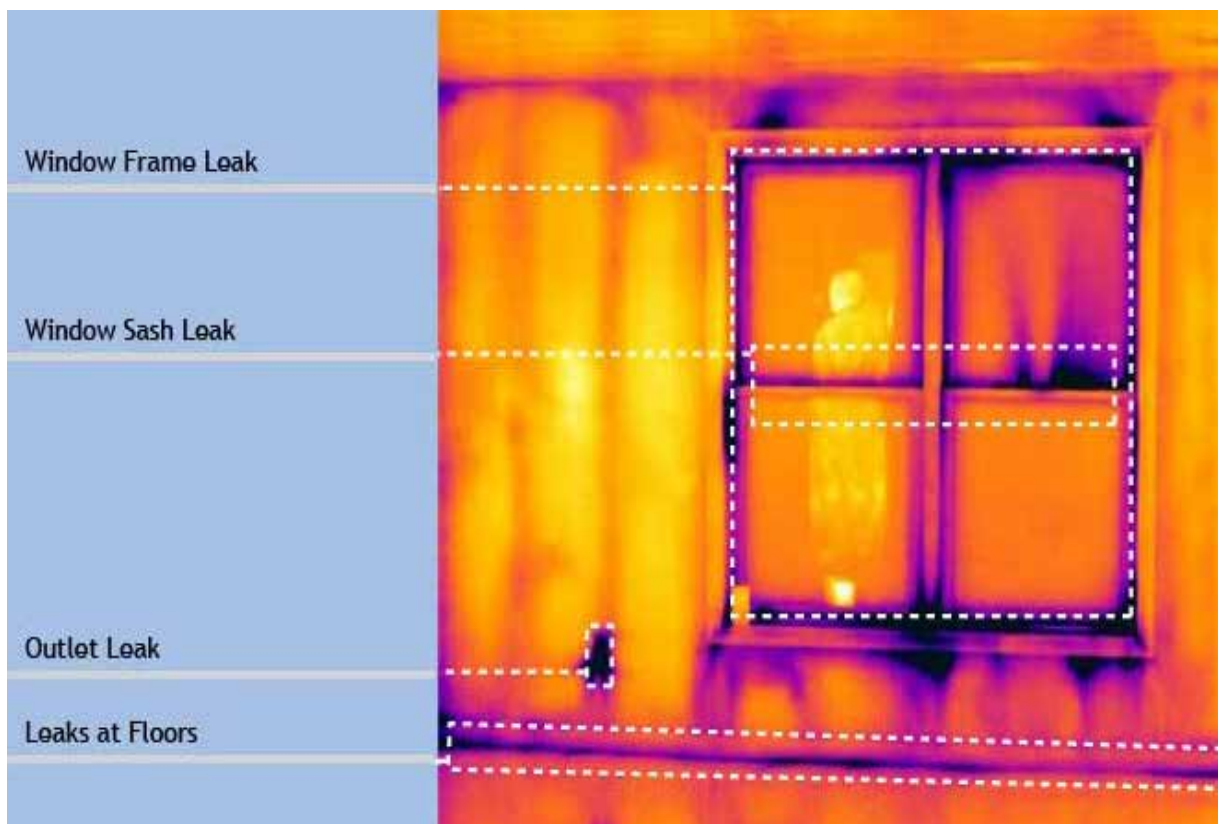

THERMAL IMAGING



## STEP 3: OPTIMIZE CURRENT PERFORMANCE

Following evaluation, optimizing performance of existing systems to ensure they are operating efficiently may provide energy savings without making significant alterations or investment. HVAC, electrical and lighting systems, and the building envelope should all be considered for optimization. Typical measures to optimize performance of existing systems includes weatherizing, changing filters and cleaning and repairing existing equipment and converting to LED bulbs.

Studies have found that optimization of current performance is one of the most cost-effective procedures to increase the energy efficiency of existing buildings and have improved operations. Optimizing existing systems is a fundamentally sustainable approach that minimizes changes to the building envelope.

Weatherization, improving ventilation and enhancing insulation are all methods for reducing air, water, and vapor infiltration, and making a building more efficient. These and other methods for optimizing current performance are discussed more fully in Section III.

## STEP 4: DEFINE YOUR GOALS

After evaluating current performance and optimizing existing equipment and systems, define goals and priorities for the green retrofit to determine the strategies to implement. As goals are being identified, a cardinal rule on any existing or historic building should be “do no harm”— for example, don’t create new problems by trapping moisture, creating condensation, or causing deterioration.

Examples of goals could include:

- Reaching a specific energy usage target or a specific percentage in reduction;
- Meeting code requirements or specific standards such as LEED or PassiveHaus;
- Reducing monthly energy costs;
- Improving comfort;
- Setting specific return on investment goals or payback periods for potential renovations;
- Meeting project-specific air infiltration requirements;
- Producing renewable energy.

## STEP 5: DEVELOP A COORDINATED PLAN

A green retrofit will require a comprehensive planning approach that evaluates the building and its systems holistically to provide the greatest energy savings. The plan should be designed and tailored specifically to your building, site, character-defining features, climate, and occupancy.

Because retrofit strategies range in cost and complexity, it is important to develop a coordinated plan based on needs and goals determined in Steps 2, 3, and 4. If the primary goal is to reduce energy bills, start small by evaluating user behavior, taking advantage of passive and inherently sustainable features, optimizing existing systems, and implementing other cost-effective strategies. If the goal is to meet net-zero energy, or to reduce energy use by a certain amount, the plan will need to take a longer-term, multi-system approach likely utilizing multiple retrofit strategies.



## PLANNING FOR MAJOR UPGRADES

While planning a retrofit and implementing these strategies, keep in mind the following list of ideal circumstances and points in time for major upgrades to occur. When these circumstances arise or significant end-of-life replacements are needed, you may be able to include additional energy-efficiency improvements at minimal added cost.

- **Building Purchase or Refinancing:** when financing, a retrofit can be included in the transaction cost.
- **Major Renovation or Improvements:** if planning a major renovation or project, or replacing mechanical equipment that is near the end of its service life, energy-efficient upgrades could be incorporated at minimal additional cost.
- **Building Envelope Improvements:** when combined with major end-of-life equipment upgrades, such as HVAC, improvements to the building envelope offer opportunities for reduced costs because of reduced heating and cooling loads that will require smaller and less expensive mechanical equipment.
- **Life Safety and Code Requirements:** if implementing life safety or code requirement upgrades that require substantial cost and effort, energy-efficiency upgrades may be incorporated with minimal additional investment.
- **Tenant Turnover:** in rental properties, tenant turnover may provide an opportunity to improve efficiency and increase the value of the space.
- **Portfolio Management:** if managing a portfolio of properties, it may be beneficial to implement a set of replicable energy-efficiency upgrades as part of an ongoing management plan.

## CONSIDER MATERIAL LIFESPANS AND IMPACTS

While considering appropriate strategies you should also recognize the lifespan of the building's materials and components, such as the following:

- Older materials and assemblies, including masonry walls, slate roofs, or wood windows are generally intended to be repairable and have a long lifespan. Minimize intrusions, alterations, and long-term impacts to these features.
- Complex systems will require more maintenance to perform properly. Passive and inherently sustainable features require little energy and maintenance to perform.
- Design systems that will allow repairs and replacements without disrupting the entire building or damaging character-defining features.



## IDENTIFY FINANCING OPPORTUNITIES

All strategies should be evaluated for their cost-effectiveness. The initial cost of a product or design is only part of the true cost and often long-term operation costs exceed initial costs. Consider the long-term savings and ease of maintenance when budgeting for a retrofit and energy-efficient upgrades, and analyze prospective investments based on their expected financial and environmental benefits (maintenance savings, utility bills, comfort).

There are a wide range of incentives, resources and financing opportunities available to District residents for implementing green retrofits and energy-efficient upgrades. Section VI includes a list of some available resources and opportunities.

## OBTAINING PROFESSIONAL SERVICES

Depending on the size and scope of your project, you may want to consider consulting professionals to address specific retrofit or design challenges. Larger projects will likely require integrated teams that should be formed early in the planning process. Typical professionals involved in green retrofits include:

**Licensed Architect** - Designs renovations, ensure consistency of plans with applicable codes, advises on construction, and provides guidance on selection of material finishes. Identify professional architects with experience working on high-performance, green building or historic renovations.

**Historic Preservation Professional** - Advises on treatments to ensure character and integrity of the historic building is maintained during the upgrade.

**General Contractor** - Oversees day-to-day activities and manages subcontractors.

**Energy Auditor** - Inspects, surveys, and analyzes energy flows of building to maximize comfort, efficiency, health, safety, and durability.

**Structural Engineer** - Evaluates structural integrity, which may be needed if installing a green roof or other upgrades that require support.

**Sustainability Consultant** - Assesses goals and identifies appropriate strategies and experts required to facilitate an integrative design.

**Mechanical and Building Envelope Engineer** - Evaluates mechanical systems, and design improvements or replacements, conducts whole building energy analysis, blower door testing, hygrothermal analysis, and other evaluations.

# STEP 6: MAINTAIN AND MONITOR PERFORMANCE

Existing buildings should be maintained regularly to preserve character-defining features and maximize reliability, performance, and operational efficiency. During and after implementation of upgrades, you should regularly monitor performance to determine how strategies are working and where adjustments need to be made in your long-term plan.



SOLAR DECATHLON ON THE MALL



### III. GREEN RETROFIT STRATEGIES

This section includes strategies and guidelines to facilitate green retrofits of older buildings organized by particular building components. The combination of strategies selected for a building should align with project goals and consider inherently sustainable and character-defining features. The building components discussed include:

- Walls and Roofs
- Windows and Doors
- Roof Installations
- Landscape and Site Features



BRICK ROWHOUSES IN GEORGETOWN HISTORIC DISTRICT



## WALLS AND ROOFS

Exterior walls and roofs are the most visible components of a building, and for historic buildings are also important aspects of the building's character. Typical wall materials of older buildings in the District include brick (the most prevalent), wood, and stone; cast stone, stucco, terra-cotta, and glass block are also found.

Older brick buildings generally consist of multi-wythe walls, meaning a wall consisting of multiple thicknesses of brick. Frame houses have wood frames generally covered with clapboard siding, shingles or stucco. The typical interior wall finish for both construction types is plaster on lath unless later replaced with drywall.

Roofs are also often distinctive features of historic buildings. Their shape, materials and detailing contribute to a building's appearance and character. Roofs can be flat, low-sloped or steep-sloped, and can be covered with metal, slate, clay tile, asphalt or wood shingles, or built-up or rubber roofing. Most rowhouses, semi-attached residential buildings and commercial buildings have inconspicuous flat roofs, usually paired with a character-defining architectural feature, such as a cornice, parapet or pent roof.

Providing proper ventilation and insulation for walls and roofs is one of the most cost-effective strategies for improving the energy efficiency of older buildings. Improving ventilation and insulation are also easy to do without impacting the character of older and historic buildings.



ROWHOUSE TURRET WITH SLATE ROOF

## VENTILATION

Inadequate ventilation can lead to stagnant air, increasing the amount of moisture and heat build-up in interior spaces. For residential construction, this moisture and heat can flow into the attic when no dedicated air sealing is provided between the attic and living spaces below. Venting the attic with louvers in gable ends, ridge vents, and soffit or eave vents can increase air flow and help control moisture and heat build-up.

However, venting can negate whole-building air sealing and result in energy loss from unwanted air exfiltration or infiltration. To avoid energy loss, air sealing and insulation can be provided to separate the attic from interior living spaces to prevent interior conditioned air from flowing into the attic. Attic venting can be provided to prevent moisture build up, and keep the space cooler. Improving ventilation both to attics and interior living spaces, with a combination of appropriate natural (passive) and mechanical (active) ventilation and whole-building air seals can improve air circulation, keep the building cooler and reduce moisture build-up.

Roof eaves and attics are common areas for thermal and air barrier inefficiencies, allowing for conditioned interior air to escape. Improving the air tightness of the ceiling assembly, or providing a dedicated air barrier above the conditioned space can improve energy efficiency while maintaining passive ventilation.

For proper passive ventilation, the insulation should be held back a minimum of 1 inch from the underside of the roof sheathing at the roof eave and continue up the roof slope to connect with gable end vents and/or ridge vents. Radiant barriers or panels along the underside of the rafters may help reduce cooling loads.

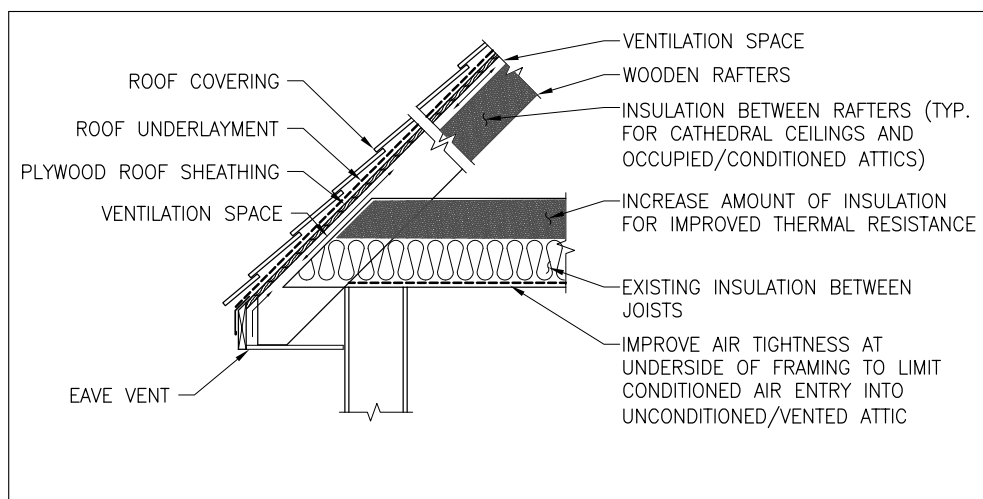

ROOF EAVE VENT

**Ventilation** can be passive (e.g. operable windows and vents), active (e.g. mechanical circulation) or a combination of both to help condition interior spaces. Older and historic buildings almost always had a combination of passive and mechanical ventilation, while many modern commercial buildings only employ mechanical ventilation.

## WALL INSULATION

While adding exterior insulation to walls can provide an effective increase in thermal efficiency, this will typically have an adverse impact on the exterior aesthetic and character of an historic building, and should not be undertaken on primary elevations. Installing insulation from the interior is the more appropriate option for older buildings. The wall assemblies below show possible interior insulation upgrades; the details shown must be evaluated to confirm that the addition and amount of interior insulation will not cause damage to the existing historic materials.

Insulating the interior side of mass masonry walls, those that are 8" thick or larger, should be reviewed by a building envelope professional. Mass masonry walls are intended to “breathe”, allowing them to absorb, store and evaporate moisture on both the interior and exterior. Insulation on the interior may hinder needed evaporation, causing the wall to stay wet for a longer period of time and potentially leading to damage by freeze/thaw cycling. A building envelope professional can evaluate whether an existing masonry wall is durable enough to allow for interior insulation.

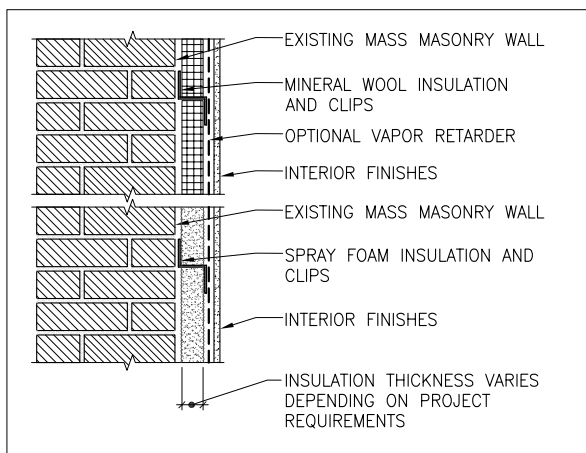

MASS MASONRY WALL WITH INTERIOR INSULATION

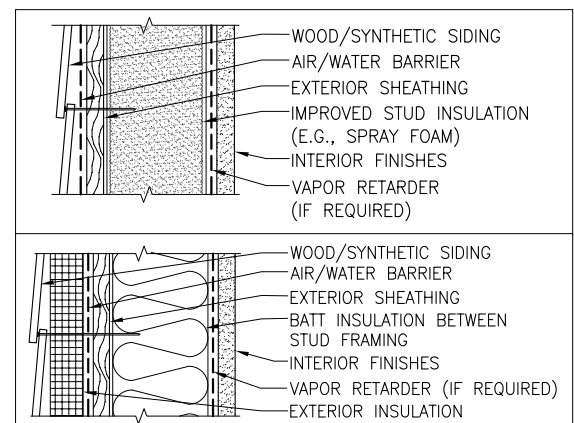

FRAMED WALL WITH VENEER

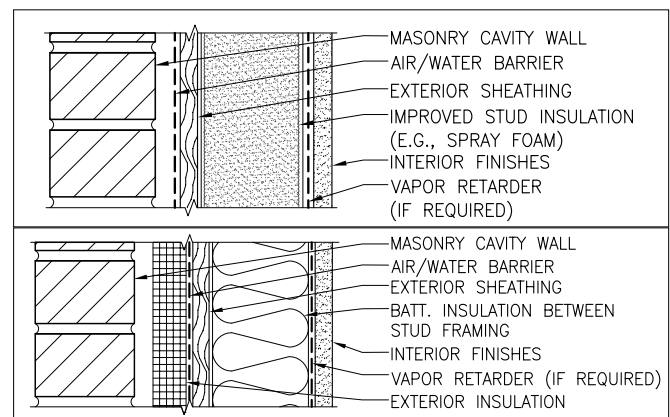

FRAMED WALL WITH MASONRY VENEER

**R-value:** Measure of thermal resistance of a material or an assembly (such as a wall or a roof). An R-value is a quantitative measure of resistance to heat flow (e.g. insulation). A high R-value indicates a high resistance to heat flow, and a low R-value indicates a more conductive material (e.g. masonry or metal).



## ROOF INSULATION

Insulating a roof or attic space is typically the most important step towards increasing energy efficiency of an older building, and energy codes are progressively requiring increasing performance levels for roof insulation. There are several options for adding additional insulation to existing roof assemblies including insulation above the roof deck, below the roof deck, or in the attic space below the roof.

Installation of rigid insulation above a roof deck works best for low-sloped roof assemblies, either a wood-framed structure typical of residential rowhouse construction or a concrete or steel structure typical in commercial construction. The details below show a common low-slope roofing assembly with the insulation above the membrane, and several types of overburden to weigh down the insulation. Rigid insulation may also go below the roofing membrane.

Insulation installed below the roof deck is typically used on steep-sloped roof assemblies. Insulating along the underside of the roof deck between the rafters increases the total conditioned space in the building, and is required for open cathedral ceilings or when temperature or moisture-sensitive mechanical equipment is placed in the attic space. Alternatively, insulating the attic floor with batt or blown-in insulation between the ceiling joists can be used when it is not necessary to condition the attic space. Regardless of the insulation arrangement, ventilating the space above the insulation by way of eave, gable or ridge vents is critical for passive ventilation.

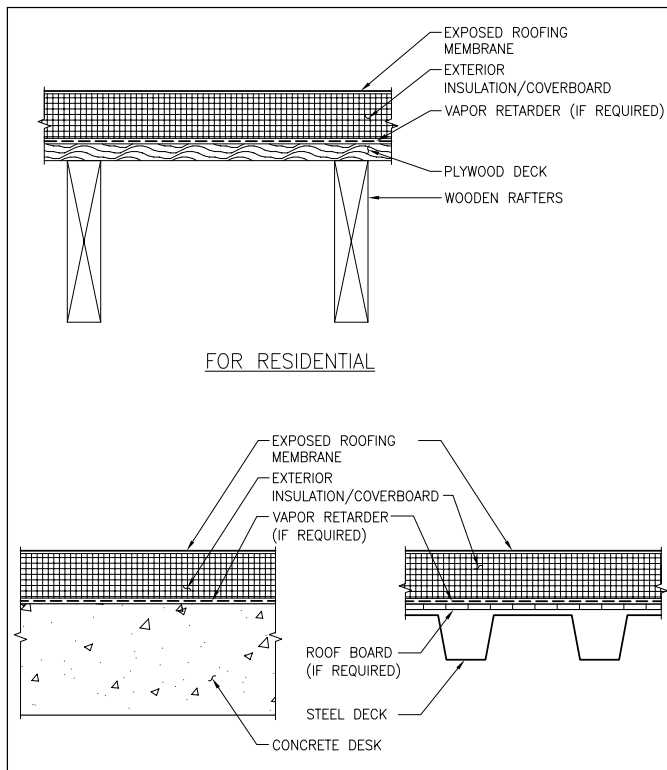

TYPICAL LOW-SLOPE ROOFING ASSEMBLIES

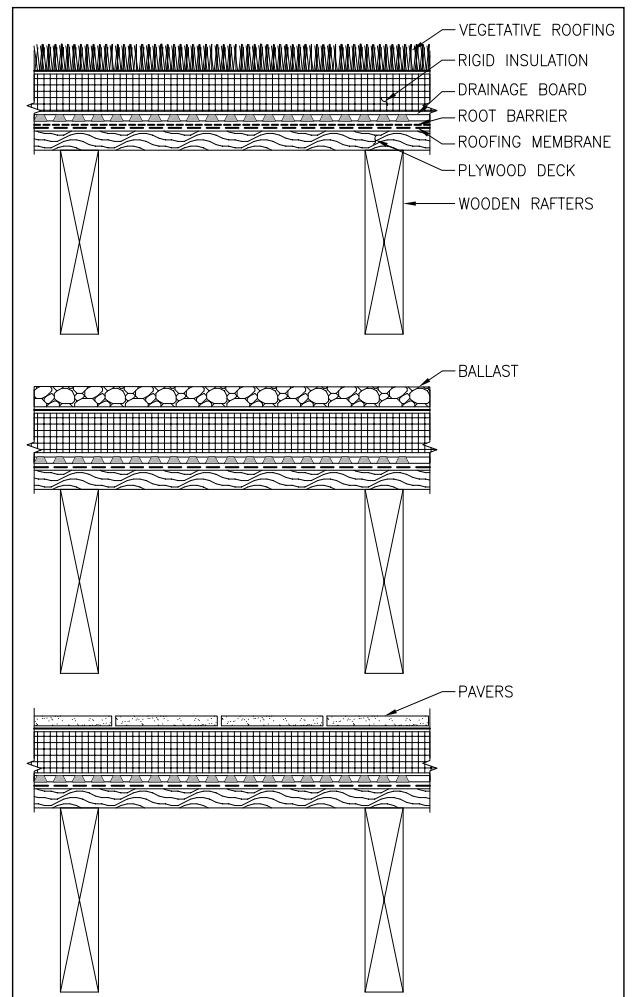

TYPICAL COMMERCIAL LOW-SLOPE ROOFING ASSEMBLY



RIGID INSULATION ON A SLOPED ROOF



BATT INSULATION BETWEEN THE CEILING JOISTS

## COOL ROOFS

Light colored and reflective roofing materials can provide a multitude of benefits, both for the building and the surrounding community as a whole. By reflecting a higher percentage of the sun's energy, the building stays cooler reducing cooling loads in the warmer months, while also improving the urban heat island effect by reducing the overall temperature in the surrounding area. When paired with solar PV systems, cooler roofs can improve panel efficiency and thus increase energy production.



ROOF MEMBRANE REPLACEMENT

## QUICK TIPS: Walls and Roofs

- Begin by focusing on the building envelope. A building's height to area ratio (i.e., is the building taller than it is wide, or wider than it is tall), can provide a good starting point in deciding where to focus efforts. A large, low building may benefit from a retrofit to provide roof insulation more than a retrofit to add additional wall insulation.
- Coordinate strategies with information learned from energy audits, Infrared surveys, and blower door tests.
- Consider continuous or comprehensive insulation layouts and their appropriateness for repairs, additions, and new buildings.
- Identify and preserve inherent thermal properties of the building and determine appropriate insulating measures for the characteristic features and climate.
- Evaluate material durability and expected service life of existing and replacement materials when considering repairs, rehabilitation, or replacement of walls and roofing. For instance a slate roofing shingle, which has a high upfront cost, can have a 75+ year lifetime, compared to an asphalt roofing shingle, which has a 15+ year lifetime.
- If installing a new roof, consider installing insulation or undertaking other energy-efficient strategies that may require minimal added cost.
- Refer to the DC Historic Preservation Design Guidelines: *Walls and Foundations of Historic Buildings and Roofs of Historic Buildings*



## LOWER COST STRATEGIES: Walls and Roofs

Roof Insulation	<ul style="list-style-type: none"> <li>• Add either batt insulation in the attic floor to prevent heat loss/gain through the attic space, or insulation hung against a sloped roof deck to provide a conditioned attic space.</li> </ul>
Roof Vents and Air Circulation	<ul style="list-style-type: none"> <li>• Provide attic vents—such as louvers in gable ends, ridge vents, or soffit vents—to allow for air flow within the attic area.</li> <li>• Install attic and ceiling fans to help vent and circulate air and to improve occupant comfort.</li> </ul>
Roof and Wall Air Sealing	<ul style="list-style-type: none"> <li>• Evaluate wall-to-roofing transitions—areas which can include improperly-detailed connections—for opportunities to reduce air leakage or heat transfer.</li> <li>• Replace interior and exterior perimeter sealant, weatherstripping, or loose and missing wall and roof sheathing.</li> </ul>

## HIGHER COST STRATEGIES: Walls & Roofs

Walls (Frame Buildings)	<ul style="list-style-type: none"> <li>• Provide additional wall insulation, either in the form of exterior cavity insulation or interior insulation between stud framing to increase thermal performance. Where possible, provide continuous insulation without thermal breaks (such as studs or similar wall elements) interrupting the insulation.</li> </ul>
Walls (Masonry Buildings)	<ul style="list-style-type: none"> <li>• Repoint exterior masonry to provide increased wall durability, and limit air and water infiltration.</li> <li>• Conduct a hygrothermal analysis by a building professional when considering insulation on mass masonry walls to avoid negatively affecting the durability of the walls and wall finishes.</li> </ul>
Roof Membrane	<ul style="list-style-type: none"> <li>• Install a “cool-roof” membrane that reflects the sun and absorbs less solar radiation.</li> </ul>
Roof Insulation	<ul style="list-style-type: none"> <li>• Add roofing insulation in conjunction with a roofing-membrane/system replacement project.</li> </ul>

## GUIDELINES: Walls and Roofs

1. Retain, preserve and repair character-defining features of walls and roofs, including finish materials, functional elements and decorative features.
2. Avoid making new penetrations through primary elevations, limiting air intake and ventilation through secondary elevations or through the roof. Seal new penetrations appropriately to prevent air and water entry.
3. Introduce insulation and ventilation features in a way that will not damage or result in loss of character-defining features of the building.
4. New exterior wall and roof finish materials should convey a similar scale, texture and visual appearance to those originally found on the building.
5. For properties with significant historic interiors, minimize or avoid changes to the proportional relationships of wall to trim and wall to window caused by furring out walls for interior insulation.

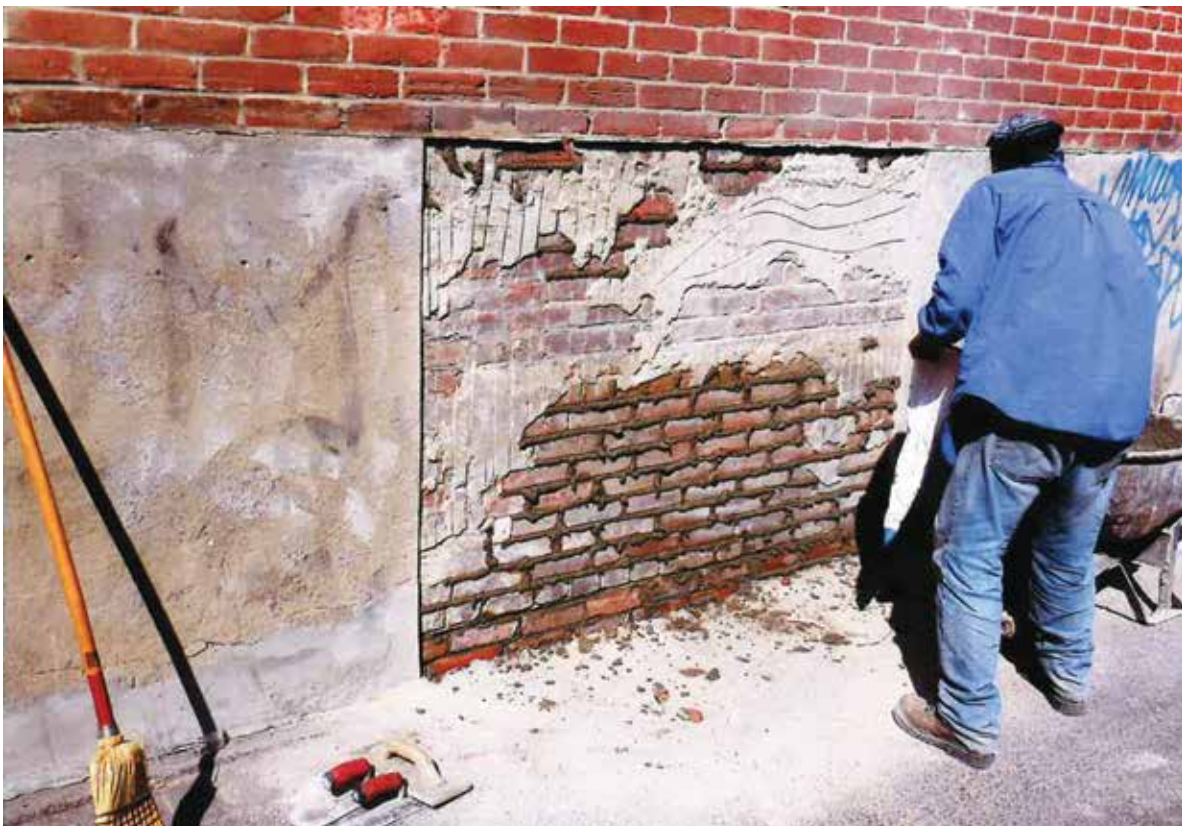







# WINDOWS AND DOORS

Windows and doors are often important architectural features of older buildings in providing a sense of scale, craftsmanship, proportion and architectural styling. Most windows on older buildings are constructed of wood with a painted finish. Windows come in a variety of styles and configurations, and can be as simple as a single pane of glass in the upper and lower sashes, or have multiple panes in each.

Windows require regular maintenance and repair. In many historic buildings, the typical ratio of fenestration (i.e., windows, skylights, glass doors) to the total exterior wall surface area is around 20%. Consequently, the large expense for a full window or glazing replacement will only improve a limited area of the exterior enclosure, and may not be a cost-effective solution given the long pay-back period based on the projected energy savings from the upgrade in window performance. However, this option may be justifiable if there are other reasons for replacing the windows, such as window failure. Conversely, upgrading the remaining opaque area of the exterior (walls and roof) and undertaking improvements to the existing windows (e.g., air sealing, storm windows) may provide a better return on investment while also retaining an important character-defining feature. Window replacement should be thoughtfully considered in the context of all other potential energy retrofits.

Historic wood doors are also significant features and should be retained where possible. While an insulated replacement door may have more thermal resistance, doors represent only a small area of the total exterior wall surface and may not have a significant effect on the overall building energy performance. Similar to windows, maintenance of the existing doors, including regular painting and renewed weatherstripping, can be the most effective, low-cost strategy for improving energy performance.

Regular maintenance and replacement of interior and exterior perimeter seals, gaskets, and weatherstripping around windows and doors, especially at operable units that rely on the continuity and compression of these components to resist air infiltration and water penetration, can significantly improve their energy performance.



## QUICK TIPS: Windows and Doors

- Perform regular maintenance on older windows and doors to ensure functionality and weathertightness.
- Apply weather stripping, install storm windows and doors, and undertake basic repairs to windows and doors to improve thermal efficiency.
- Repair or reopen transoms to improve air flow and cross ventilation.
- Maintain, repair, or reinstall operational shutters and awnings.





## LOWER COST STRATEGIES: Windows and Doors

<p>Weatherstripping</p>	<ul style="list-style-type: none"> <li>• Add weather stripping to existing windows, which can increase the energy efficiency of windows by as much as 50%.</li> <li>• Tighten the seal around the window and between the upper and lower sash, to make windows more energy efficient. The majority of heat loss through historic windows occurs around the perimeter of the sash rather than through the glass.</li> <li>• Replace interior and exterior perimeter sealant and putty glazing, which generally have significantly shorter lifetimes than wood and glass window components.</li> <li>• Use joint fillers, caulk, glazing putty and sealants to seal cracks and openings on non-moving parts such as around frames and glazing. Use metal, silicone, rubber or felt weather stripping on moving window elements to provide a tighter fit without sealing them shut.</li> </ul>
<p>Locking Mechanisms</p>	<ul style="list-style-type: none"> <li>• Repair or replace locking mechanisms to prevent excess air and heat loss through the window perimeter.</li> </ul>
<p>Window Treatments</p>	<ul style="list-style-type: none"> <li>• Add interior shading or window treatments to minimize heat gain or loss through windows.</li> </ul>



WINDOW WEATHERSTRIPPING



WINDOW TREATMENTS



## HIGHER COST STRATEGIES: Windows and Doors

<p>Storm Windows/Doors</p>	<ul style="list-style-type: none"> <li>• Install interior or exterior storm windows to improve thermal efficiency. Storm windows provide additional insulation in the air space between the existing window and the storm. To be effective, ensure a proper seal between both the glass and the frame and the frame and the wall.</li> <li>• Install storm doors to improve the thermal performance of historic doors. Storm doors should be compatible with the appearance of a historic door, such as a fully-glazed storm door with a frame that matches the color of the existing door or trim.</li> </ul>
<p>Reglazing Windows</p>	<ul style="list-style-type: none"> <li>• Retrofit thermal glazing into existing single-glazed sash to improve the energy efficiency of historic windows while retaining the original sash and frame. Double-insulated glass within existing sash can provide a comparable level of energy efficiency as a standard new double-glazed unit if done in concert with the installation of weatherstripping.</li> </ul>
<p>Window Replacement</p>	<ul style="list-style-type: none"> <li>• If original windows are deteriorated beyond repair, replace existing windows with new insulated windows.</li> <li>• Select replacement windows and doors that are durable, repairable and recyclable.</li> </ul>



STORM DOOR



WINDOW REPAIR

## GUIDELINES: Windows and Doors

1. Retain, preserve and repair original windows and doors unless repair is not a feasible option.
2. Replacement windows and doors on primary elevations should closely match the historic appearance. New windows and doors should fit properly within the original openings, replicate the pane configuration, dimensions and profiles of the sash or door leaf, and match the finish and visual qualities of the historic windows and doors.
3. Replacement of windows and doors on secondary elevations should relate to the general character of the building or district but alteration of the original condition is permitted.
4. Use clear (low-e) glass or film on replacement windows and doors that is without a noticeable tint or color.
5. Refer to the DC Historic Preservation Design Guidelines: *Window Repair and Replacement, Door Repair and Replacement, and Signs, Awnings, Canopies and Marquees.*



# SOLAR AND GREEN ROOF INSTALLATIONS

Roof installations to capture storm water or to generate renewable energy are increasingly common in the District, including on many older and historic buildings. As of 2019, over 1400 buildings in historic districts have been retrofitted with solar installations. With the District having recently passed a renewable energy requirement that is more aggressive than any state in the country—requiring that 100% of the city’s energy be produced by renewable sources by 2032—with 10% generated by solar energy systems located in the District or on feeders serving the District—it is imperative that our city’s older and historic buildings fully contribute to this goal.

Installation of solar and green roof systems need to take into account a variety of factors. These include the building’s structural capacity, orientation to the sun, surrounding buildings and vegetation, and zoning and building code requirements. For historic buildings, there is also a requirement that installations be compatible with their architectural and neighborhood character. While most historic buildings can be retrofitted with solar in a manner that respects their architectural character, there may be limited instances in which solar is not feasible or appropriate. Fortunately, with thinner panels, solar film systems, solar-integrated roofing materials, and other emerging technologies, there are an increasing number of options available for compatibly integrating solar into older and historic buildings. And if, for whatever reason, installing solar on your building is not feasible, DC’s community solar laws make it possible to benefit from and support solar. Community solar programs allow you to purchase a subscription in a community solar project, or start a project with your neighbors, with a credit provided on your electricity bill for the energy produced by your subscription (for more information, see Additional Resources on page 64).

The design guidelines for solar and green roof installations on page 41 are intended to promote these types of installations in a manner that retains historic building characteristics and minimizes alterations that could adversely impact an historic building or district. The Historic Preservation Review Board (HPRB) has authorized the Historic Preservation Office to approve solar and green installations that are consistent with the principles outlined in the guidelines. Proposals that are not consistent with the guidelines may be submitted for review by the HPRB to determine whether an exception to the design principles is warranted.



GREEN ROOF ON RESIDENTIAL PROPERTY



## GREEN ROOFS

Vegetative green roofs have multiple environmental benefits. They capture or slow storm water runoff, provide insulating qualities to a building, and reduce urban heat-island effect. A green roof typically includes the following components, as illustrated below: a supporting structure, continuous waterproofing membrane, root barrier, a drainage layer/moisture retention mat system, insulation, and soil and plantings. The selection of an appropriate waterproofing membrane, combined with the proper construction of typical detailing and base flashing, is critical for providing a durable watertight long-term roofing assembly. The soil media, insulation, and drainage/moisture retention systems must all be designed to reduce the volume of runoff.

The most important first step when considering installation of a green roof is to involve a licensed architect or engineer to evaluate whether the structural capacity of the existing roof can support the installation. Supplementing the existing structure may be required. Additionally, a licensed roofing contractor or vegetative roofing supplier should be involved to assist in reviewing the relevant details, drainage, installation, and any suggested quality control measures for testing of the system.

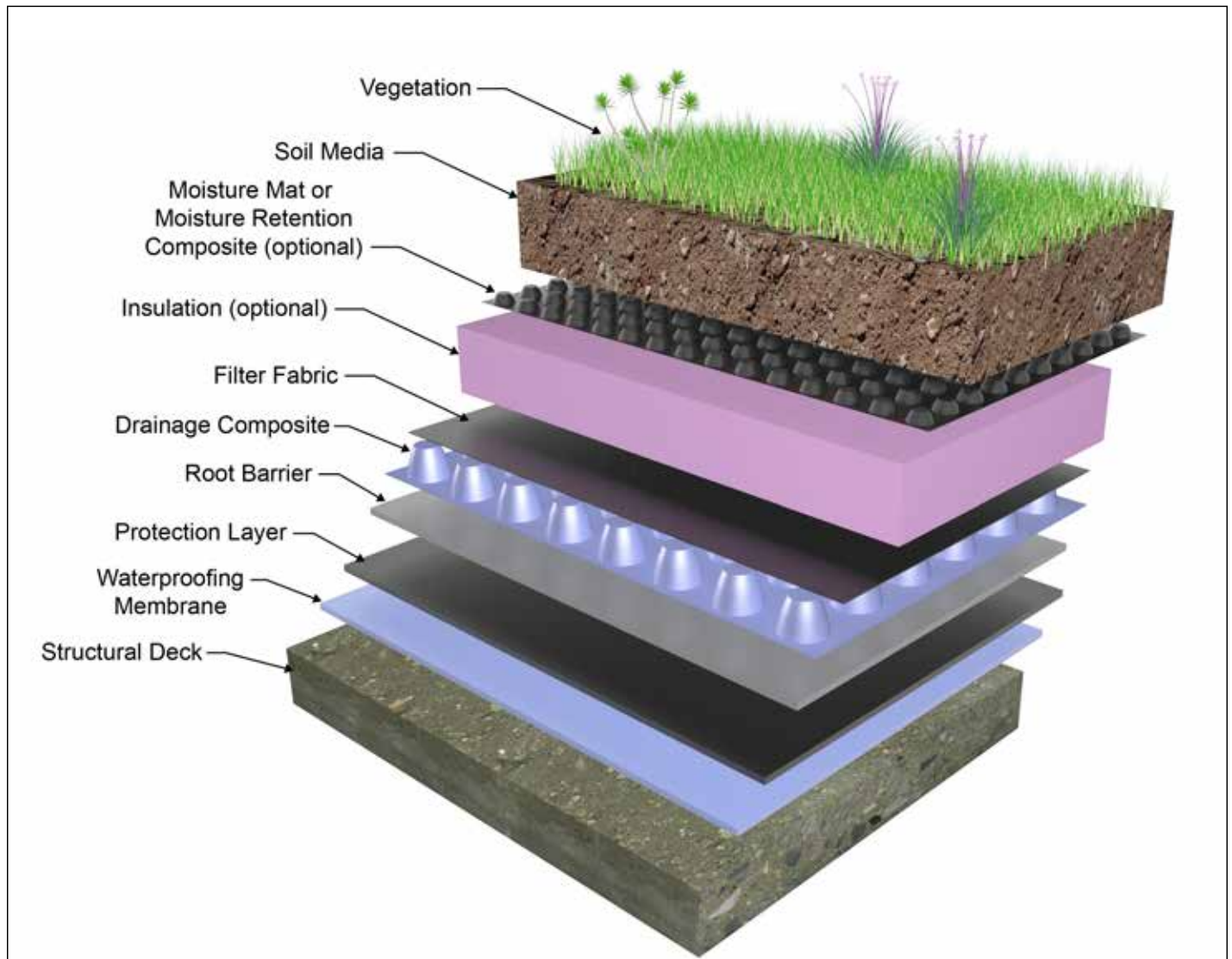

TYPICAL GREEN ROOF ASSEMBLY SHOWING THE INDIVIDUAL LAYERS AND COMPONENTS

## SOLAR PHOTOVOLTAIC (PV) SYSTEMS

Solar photovoltaic (PV) systems capture and convert sunlight into electricity. These systems can be a cost-effective and reliable producer of electricity. The basic building blocks of a PV system are solar cells. Solar cells consist of semiconductor materials, such as crystalline silicon or thin-films, that absorb sunlight and convert it into energy for immediate use or storage in batteries. There are a variety of solar cell materials available which vary in their appearance and efficiency.

PV systems are modular, meaning they can be designed to meet the specific energy needs of a building and its users. In addition to meeting the building's needs, solar systems in the District can also benefit other ratepayers outside of the building through community solar. Solar cells are generally interconnected with other cells to form flat-plate panels or modules that are installed on a building or in a rack to form a PV array. Panels can either be fixed in place or allowed to track the movement of the sun. Thin-film PVs make it possible for solar cells to double as roof shingles, roof tiles, building facades, and even glazing for skylights. These systems are still new to the residential market but have the potential to integrate renewable solar energy in a subtle and attractive way on older existing buildings.

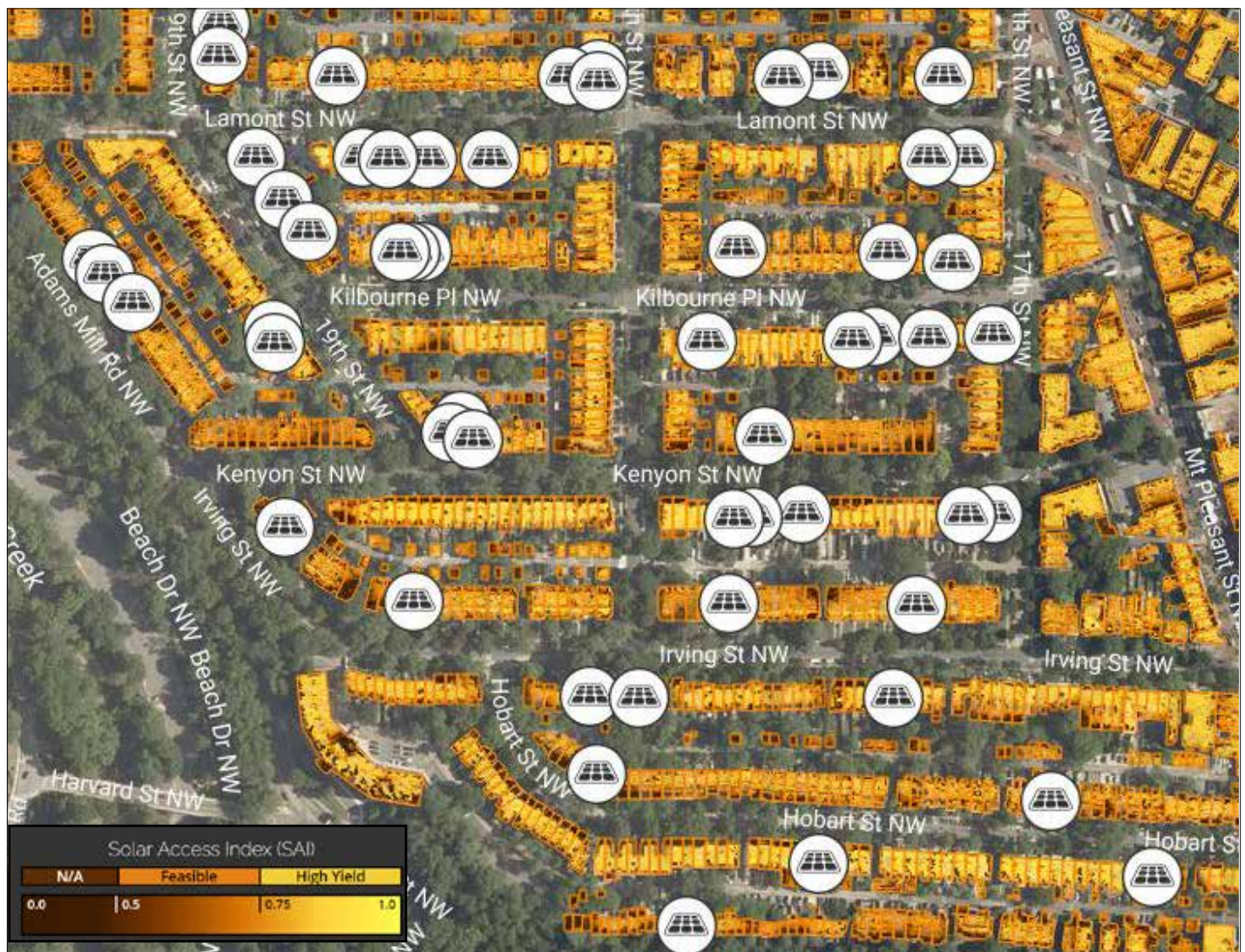

THIS INTERACTIVE ONLINE ROOFTOP SOLAR MAPPING TOOL ALLOWS USERS TO DETERMINE THEIR ROOFTOP SOLAR POTENTIAL AS WELL AS WHERE SOLAR HAS BEEN INSTALLED ELSEWHERE IN THEIR COMMUNITY.



## SOLAR THERMAL SYSTEMS

Solar thermal systems differ from PV in that they use solar radiation to provide clean heat energy for water or space heating. Systems use solar collectors, box structures with dark surfaces that are typically installed on a roof. As the liquid passes through the collector, it is warmed and then circulated through the building for use. Thermal systems use fans or pumps to circulate air or liquid through the collectors to heat for use or storage. A conventional electrical or natural gas system is typically used as a backup.



SOLAR PHOTOVOLTAIC SYSTEM ON THE JAMES V. FORRESTAL BUILDING, HEADQUARTER OF THE US DEPARTMENT OF ENERGY.



## PERMIT REQUIREMENTS FOR SOLAR INSTALLATIONS

The following information is required when submitting for a building permit application for a solar installation. These plans are typically prepared and submitted by the installer:

1. Photographs: The photos should illustrate all street-facing elevations of the building and of the roof itself. (1 below)
2. Roof plan: The plan should show existing roof features (such as skylights, chimneys, and decks), and placement of the solar installation. The plan should specify dimensions of the installation, and set backs from the front, side and rear edges of the roof. (2 and 3 below)
3. Roof section: The section should show the angle of the existing roof and the proposed solar installation, the height of the panels and their structural supports above the roof, and the thickness of the panels. (4 and 5 below)

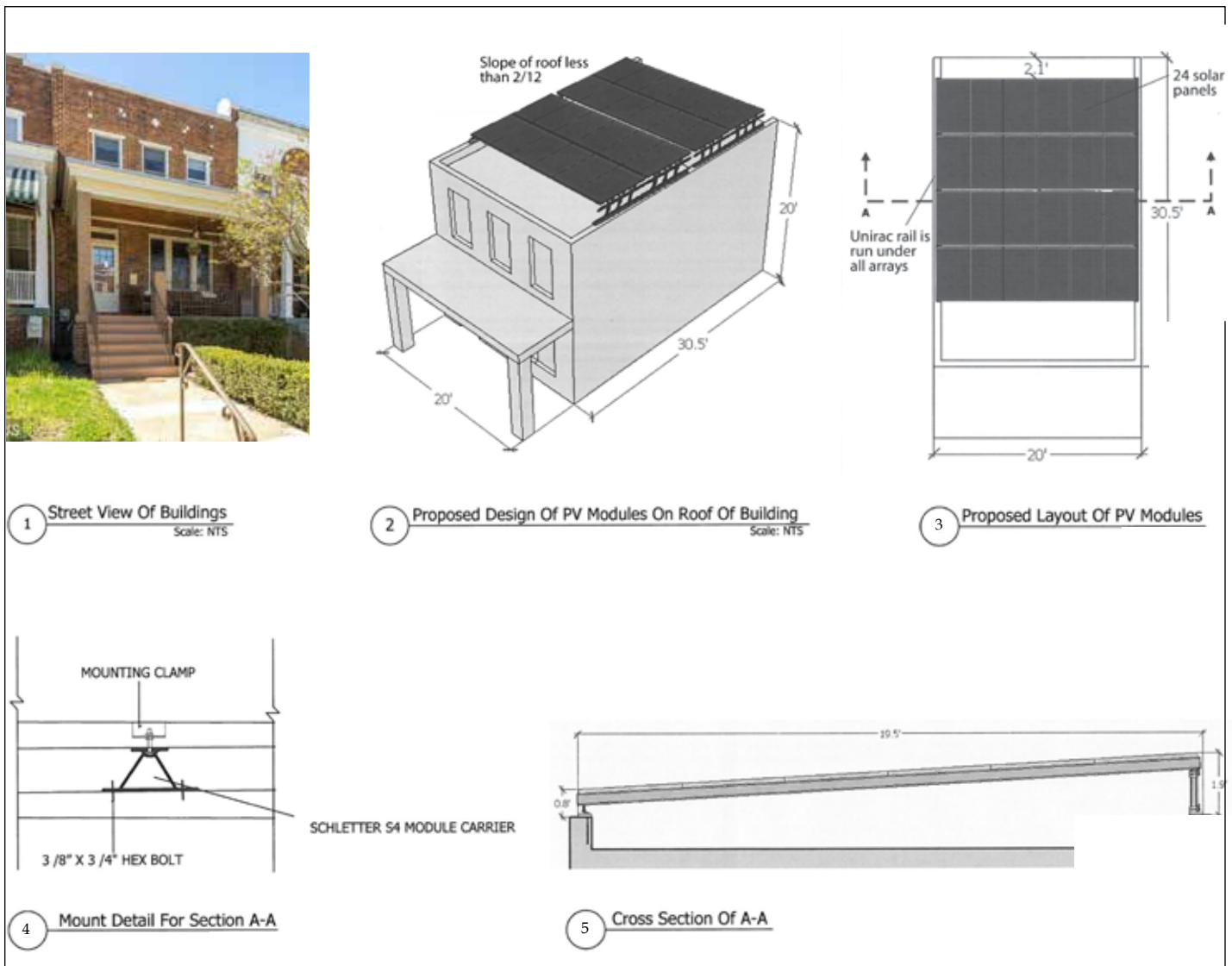

## QUICK TIPS: Roof Installations

- Engage a structural engineer or architect to assess the roof's structural capacity when considering a green roof or roof-top solar installation.
- Consult with a specialist in green roofs or solar installations, as appropriate, to ensure that the system is properly designed and scaled for your building.
- Consider the life-expectancy of the existing roof and whether replacement should be undertaken prior to installing a green roof or solar array. Ensure that the roof is water tight and has adequate slope and drainage.
- For green roof installations, implement a regular maintenance schedule and moisture-monitoring system to protect the building from added moisture, and ensure that the roof can be adequately accessed.



GREEN ROOF ON PORCH ROOF OF ROWHOUSE



## LOWER COST STRATEGIES: Roof Installations

Roof Finish	<ul style="list-style-type: none"><li>• Install a white roof finish to deflect solar rays and reduce heat gain</li></ul>
Green Roof	<ul style="list-style-type: none"><li>• Install a green roof on a secondary building, such as a shed or garage</li></ul>
Solar	<ul style="list-style-type: none"><li>• Install a solar photovoltaic or solar thermal system under lease agreement</li></ul>

## HIGHER COST STRATEGIES: Roof Installations

Green Roof	<ul style="list-style-type: none"><li>• Install a green roof on the primary building</li></ul>
Solar	<ul style="list-style-type: none"><li>• Install a solar photovoltaic or solar thermal system under a purchase agreement</li></ul>



GREEN ROOFS ON US COAST GUARD HEADQUARTERS



## GUIDELINES: Roof Installations

1. Retain original character-defining roof features and finish materials.
2. Install green roofs and solar panels so that they do not result in a perceptible change in the building's massing, height or roofline, as seen from public street view, and do not cover or obscure distinctive roof features or materials on primary elevations.
3. For buildings with flat roofs, locate green roofs and solar installations back from the front edge of the roof (and from the exposed side edge for corner properties) to minimize visibility from public street view.
4. For buildings with sloped roofs, locate solar installations on secondary elevations to minimize their visibility from public street view. If visible from public street view, use low-profile panels set flush with the roof and in a complementary color with the roof finish to avoid a discordant appearance.
5. If it is necessary to install panels on a primary elevation to achieve solar efficiency, installations should be pulled away from roof edges and ridges, compositionally balanced on the roof, and not result in irregular "saw-tooth" compositions. Use low-profile panels set coplanar and flush with the roof, and panel and panel frames that match the color of the surrounding roof. The use of a solar skin or solar shingles that match the texture and appearance of the roof is encouraged.
6. Conduit for connections to electric meters should be run inside the building or in a manner that is not prominent on a primary elevation.



A GREEN ROOF IN THE DOWNTOWN HISTORIC DISTRICT



SOLAR PANELS ON A ROWHOUSE



## EXAMPLES: Green Roofs



THIS EXAMPLE TOOK ADVANTAGE OF A REAR ADDITION, REDUCING VISIBILITY AND AVOIDING REMOVAL OF ORIGINAL BUILDING MATERIALS.



THE EXTENSIVE GREEN ROOF ON THIS COMMERCIAL BUILDING IS OBSCURED FROM VIEW BY ITS PARAPET AND CORNICE.



VISIBILITY OF THE GREEN ROOF ON THIS LOW-RISE BUILDING IS MINIMIZED BY A SETBACK FROM ROOF EDGES.





## EXAMPLES: Solar Panels



SOLAR PANELS ON THE REAR ROOF SLOPE OF THIS SEMI-DETACHED HOUSE ARE INSTALLED FLUSH TO THE ROOF AND SETBACK FROM EDGES TO MINIMIZE VISIBILITY FROM THE STREET.



PANELS INSTALLED ON THE FLAT ROOFS OF THIS ROW ARE IMPERCEPTIBLE FROM THE STREET, HIDDEN BY PARAPETS AND PENT ROOFS.



THE PANELS ON THE SIDE OF THIS HOUSE BLEND WITH THE COLOR OF THE ROOF AND ARE NOT PROMINENTLY VISIBLE.





# LANDSCAPE AND SITE FEATURES

Landscaping and site features not only improve the appearance of a property but can be a cost-effective way to reduce energy use, resource consumption, and heating and cooling costs. Landscaping and site features can also help manage storm water and reduce the phenomenon known as heat island effect.

Storm water is excessive rainfall that is unable to soak into the ground and, as a result, can cause flooding and pollution to be emptied through storm drains into the nearest body of water. Existing landscape and site features that enhance building performance, manage storm water, and improve interior comfort should be maintained and supplemented. Strategies could include removal of impervious paving and/or installation of permeable paving, installation of green roofs, reestablishment of tree canopy, incorporating bioswales or rain gardens and planter boxes, and rainwater harvesting.

The city's public space and zoning regulations restrict excavation and altering topography in front yards and in public space; front yards are also the most common location for below-grade gas, water and sewer connections. As the roofs of most urban row buildings drain to the rear (rather than to the front) rainwater harvesting and the installation of bioswales and cisterns is most appropriate in side or rear yards. The character of front yards in the city's rowhouse and suburban neighborhoods is primarily unpaved, landscaped green space. Paving should be limited in front yards to reduce impervious surfaces and to retain neighborhood character.



EXAMPLE OF BIOSWALE

**Bioswales** are landscape elements designed to concentrate or remove debris and pollution out of surface runoff water. They consist of a swaled drainage course with gently sloped sides (less than 6%) and filled with vegetation, compost and/or riprap.

**Green Infrastructure:** Many of the following strategies are considered green infrastructure, which is an approach to stormwater management that works to restore the natural processes required to manage water and improving human health.

## GEOHERMAL SYSTEMS

Geothermal heat pump systems (GHPs), also known as ground-source heat pumps, take advantage of the relatively constant temperature stored below the earth's surface (50-60 degrees Fahrenheit) to provide heating and cooling in buildings. A ground loop is a heat exchanger, similar to a cooling coil or an evaporator in a chiller, that either extracts or adds heat to the ground. There are four types of ground loop systems: horizontal, vertical, and pond/lake (all closed-loop systems), and open loop. The type of system depends on the climate, soil conditions, available land, and installation costs. In the District systems are generally vertical, closed-loop.

GHPs are extremely efficient, last a long time, and are typically well suited for historic buildings because they require little equipment and are not visually intrusive. When compared to traditional HVAC systems, they require less equipment, have fewer moving parts, provide better zone space conditioning, and maintain better internal humidity levels. GHPs can cut energy bills by up to 65%. The cost for geothermal systems can be high as they require drilling and placement of wells deep below grade, though typically, energy cost savings allow the investment to be recouped within two to ten years.



DIAGRAM OF A TYPICAL VERTICAL, CLOSED-LOOP SYSTEM

**Urban Heat Island Effect:** Extensive paved surfaces in urban areas are known to raise ambient temperatures above those of the surrounding region. As a result, downtown is sometimes 10-15 degrees hotter on summer afternoons than surrounding neighborhoods. The increased temperatures lead to greater ozone production and poor air quality.



## QUICK TIPS: Landscape and Site Features

- Identify and retain existing inherently sustainable features such as permeable paving and mature trees that block summer sun or serve as a wind break.
- Place new trees and landscaping away from foundations or basement walls to avoid moisture infiltration and damage from roots. Select plant and tree species according to their mature size to account for the long-term impact of mature growth.
- Prevent vines, ivy, and other plants from growing directly on building or site walls, as they can cause damage to underlying materials.
- Avoid paving up to the building foundation with impermeable surfaces as this can increase building temperature, cause damage to the foundation, and trap moisture.
- Consider permeable paving options when installing new or replacement paving.
- Ensure protection of nearby buildings, trees, site features and known archeological features when undertaking excavation or regrading for the installation of an underground cistern.

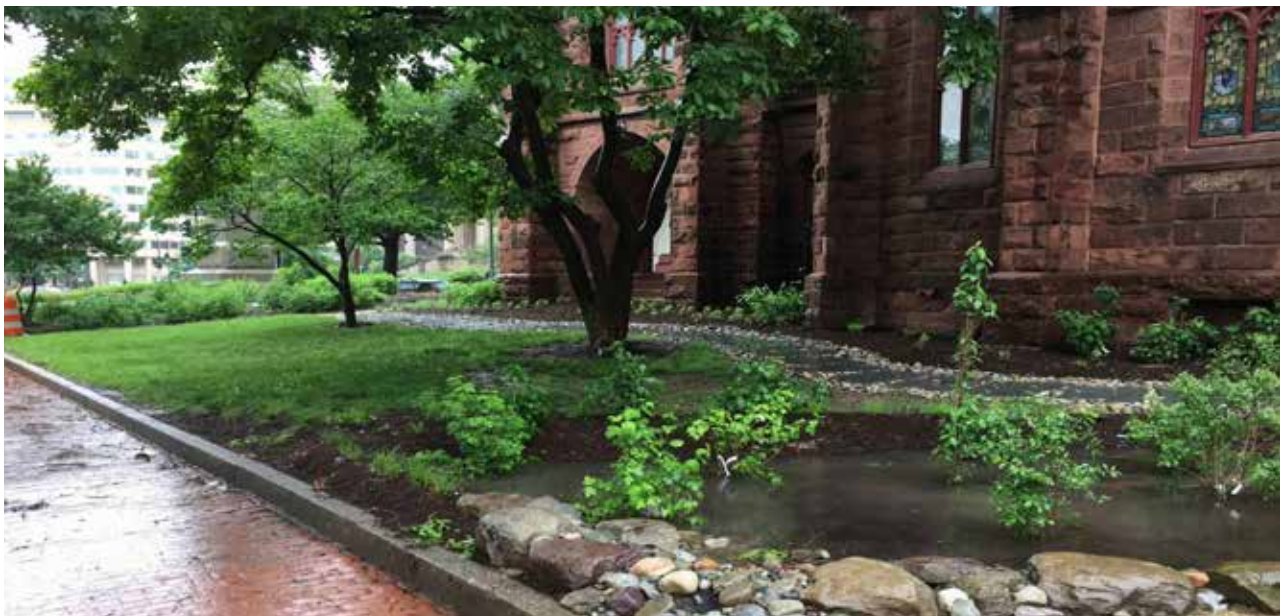

A RAIN GARDEN ON THE GROUNDS OF AN HISTORIC CHURCH

## LOWER COST STRATEGIES: Landscape and Site Features

<p>Landscaping</p>	<ul style="list-style-type: none"> <li>• Preserve existing trees and plants, particularly where mature trees are present.</li> <li>• Use native plants, shrubs, and well-placed trees to reduce water consumption and provide shade and wind protection.</li> <li>• Maintain trees to promote tree health and avoid property damage.</li> </ul>
<p>Composting</p>	<ul style="list-style-type: none"> <li>• Compost food and yard scraps to enrich soil instead of using store-bought chemical fertilizers.</li> </ul>
<p>Rainwater Harvesting</p>	<ul style="list-style-type: none"> <li>• Collect and store rainfall from rooftops or other impervious surfaces in rain barrels or below ground cisterns for on-site use. Non-potable uses include irrigation; washing sidewalks, cars or pets; refilling water features or swimming pools, and connecting to indoor non-potable fixtures such as toilets and clothes washers.</li> </ul>
<p>Water Efficient Irrigation Systems</p>	<ul style="list-style-type: none"> <li>• Install systems that reduce water consumption such as drip irrigation, soaker hoses, moisture sensors and timers.</li> </ul>



RAIN BARREL



COMPOST BARREL

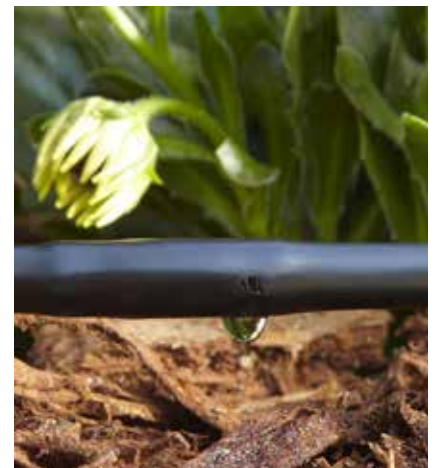

DRIP IRRIGATION HOSE

## HIGHER COST STRATEGIES: Landscape and Site Features

<p>Permeable Paving</p>	<ul style="list-style-type: none"> <li>• Install permeable paving materials to allow stormwater to filter through voids or pervious joints where it is captured in underlying layers of soil and gravel. Examples include porous asphalt, porous concrete, brick pavers, vegetated permeable pavement, and interlocking pavers.</li> </ul>
<p>Rain Gardens and Planter Boxes</p>	<ul style="list-style-type: none"> <li>• Use shallow vegetated basins or planter boxes to capture and store stormwater runoff and pass it through a filter bed of engineered soil media composed of sand, soil and organic matter. Filtered runoff may then be collected and returned to a storm sewer or allowed to infiltrate into the soil.</li> </ul>
<p>Rainwater Harvesting - Underground Cisterns</p>	<ul style="list-style-type: none"> <li>• Install an underground cistern to collect and store rainfall from rooftops or other impervious surfaces for later use. Residential cisterns typically have a capacity between about 1,500-5,000 gallons. Most cisterns have a standard pressurized plumbing system that conveys water to the house or wherever needed for use.</li> </ul>



UNDERGROUND CISTERN



PERMEABLE PAVERS



PLANTER BOX



## GUIDELINES: Landscape and Site Features

1. Identify, preserve and repair character-defining landscape features such as masonry walls, walkways and stairs, topographical features, plantings or other man-made and natural features.
2. Replace character-defining or inherently sustainable landscape features that are deteriorated beyond repair with compatible, appropriate materials and indigenous plant species.
3. Limit the extent of new paving and changes to topography, especially in front yards, to retain their natural, green character. The area devoted to paving in front yards, including for walks and areaways, should be subordinate to the area devoted to in-ground landscaping.
4. Install new paving that is compatible with the character of the building and surroundings, using permeable paving if appropriate, for walkways, driveways and patios.
5. Install rain gardens, bioswales, cisterns or other rainwater harvesting systems in a manner that is compatible with the landscape character of the property and surrounding context. Side and rear yards are typically the most appropriate place for larger landscape features that require substantial excavation or changes in topography.



GREEN ROOF AND LANDSCAPE AT A GOVERNMENT BUILDING

## IV. HISTORIC PRESERVATION REVIEW

The preservation review process is administered by the D.C. Historic Preservation Office (HPO) which has a professional staff of architects and preservation specialists who can provide architectural and technical assistance on products and methods appropriate to the renovation of older properties.

Most types of work affecting a building in the District of Columbia require a building permit. Permits ensure compliance with construction, zoning, fire, electrical, and other applicable codes to protect the safety and well-being of District residents. The HPO reviews all permit applications for exterior work on landmarks and in historic districts to ensure compatibility with the site and surrounding neighborhood. Permits are required for window, door, porch, and roof replacements; work and replacement of front steps or walks; retaining wall construction or repair; re-pointing brick masonry; installing or replacing fences; additions, new construction, and demolitions. See the table on the following pages for a complete list of projects that require a permit and HPO review.

Property owners are encouraged to consult informally with the HPO before submitting an application for exterior work. The staff can approve most types of work, such as repair and replacement and minor alterations in an expedited permit review process. More substantial projects, such as new construction and additions, are subject to review by the HPRB at its monthly meetings. Complex projects may require more than one presentation to the HPRB. The HPO staff can provide property owners or their representatives the necessary guidance and direction to obtain a building permit.



RESTORATION OF HOUSE IN LEDROIT PARK

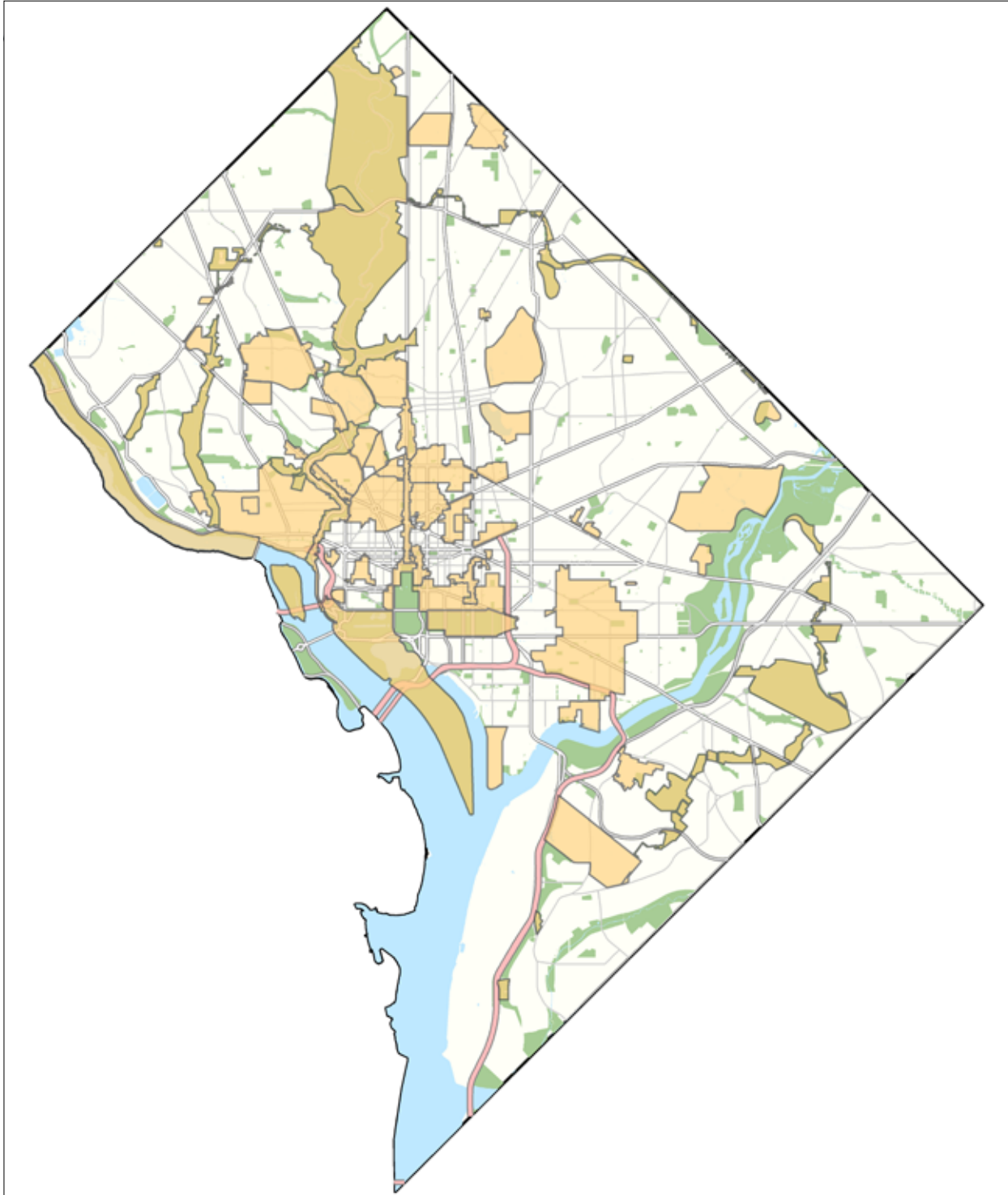

A MAP OF HISTORIC DISTRICTS IN THE DISTRICT OF COLUMBIA

For further information and full texts of the preservation law and regulations, see the HPO website:  
<https://planning.dc.gov/page/hp-laws-and-regulations>

To find out whether your property is located in an historic district, check:  
<https://propertyquest.dc.gov/>



MAJOR PROJECTS REQUIRING HISTORIC PRESERVATION REVIEW BOARD APPROVAL		PERMIT REQUIRED
DEMOLITION	<ul style="list-style-type: none"> <li>Demolition of historic landmarks or contributing buildings in historic districts, including significant demolition as defined in HPRB Regulations</li> </ul>	X
NEW CONSTRUCTION	<ul style="list-style-type: none"> <li>New buildings</li> </ul>	X
	<ul style="list-style-type: none"> <li>New two-story garages and outbuildings prominently visible from a street</li> </ul>	X
MAJOR ADDITIONS	<ul style="list-style-type: none"> <li>Front and side additions visible from a street</li> </ul>	X
	<ul style="list-style-type: none"> <li>Large rear additions (more than 250 square feet in footprint or 500 square feet on two or more levels)</li> </ul>	X
	<ul style="list-style-type: none"> <li>Front porch enclosures and new front porches (other than reconstruction of missing original porches)</li> </ul>	X
	<ul style="list-style-type: none"> <li>Roof additions and roof decks visible from a street</li> </ul>	X
MAJOR ALTERATIONS	<ul style="list-style-type: none"> <li>Front alterations, such as new dormers, entrances, and entrance features</li> </ul>	X
	<ul style="list-style-type: none"> <li>New or significant alterations to window or door openings on front facades</li> </ul>	X
	<ul style="list-style-type: none"> <li>Significant alteration or removal of important architectural features, such as special windows, distinctive materials, or decorative elements</li> </ul>	X
MAJOR SITE WORK	<ul style="list-style-type: none"> <li>New curb cuts, driveways and parking pads in front and side yards</li> </ul>	X
MISCELLANEOUS	<ul style="list-style-type: none"> <li>Subdivisions involving historic landmarks, significant changes in lot boundaries, or a major combination or division of lots</li> </ul>	X
	<ul style="list-style-type: none"> <li>Work that exceeds HPO delegated authority</li> </ul>	X
	<ul style="list-style-type: none"> <li>Work that is inconsistent with HPRB standards</li> </ul>	X

MINOR PROJECTS REQUIRING HISTORIC PRESERVATION OFFICE APPROVAL		PERMIT REQUIRED
IN-KIND OR COMPATIBLE REPAIRS OR REPLACEMENT OF BUILDING COMPONENTS	• Masonry, woodwork, metalwork, siding, trim, and other architectural features	X
	• Roofing, coping, gutters, and downspouts	X
	• Masonry pointing, cleaning and waterproofing (except by sandblasting or other damaging methods)	X
MINOR ALTERATIONS TO BUILDING OPENINGS	• Window and door replacement	X
	• Creation or closure of window or door openings	X
	• Basement areaways and window wells	X
UNOBTRUSIVE MINOR ALTERATIONS	• Rear porches and decks	X
	• Roof decks and roof access stairs	X
	• Skylights, solar installations, antennas, and satellite dishes	X
	• Plumbing, heating, ventilating, air conditioning, and mechanical equipment and installations	X
	• Utility meters	X
	• Exterior lighting fixtures	X
COMPATIBLE SITE ALTERATIONS, REPAIRS AND REPLACEMENT	• Fences, retaining walls, steps, walkways, and garden features	X
	• Patios, garden storage sheds, swimming pools, and similar private property features that do not affect historic character	X
STOREFRONTS AND PUBLIC SPACE	• Awnings, canopies, signs, storefront renovations, and unenclosed sidewalk cafes	X
	• Projection and public space permits, including occupation of public space for construction activities	X
ADDITIONS AND NEW BUILDINGS	• Building additions not exceeding 250 square feet in footprint or 500 square feet on two or more levels	X
	• Construction of one-story garages or secondary buildings	X
	• Removal or alteration of additions that do not contribute to historic character	X
	• Alterations to non-contributing buildings that are compatible with the character of the affected historic landmark or district	X
	• Work reviewed by HPRB under the conceptual design review process and delegated to HPO	X

MINOR PROJECTS REQUIRING HISTORIC PRESERVATION OFFICE APPROVAL		PERMIT REQUIRED
CONSTRUCTION ACTIVITIES	• Raze applications for non-contributing buildings	X
	• Raze applications pursuant to an approval by HPRB or the Mayor's Agent	X
	• Excavation, sheeting and shoring, underpinning, grading, blasting, and other ground disturbance	X
	• Renewal, revision, supplemental, and temporary building or public space work permits, including temporary signs, scaffolding and other construction activities	X
	• Other routine, minor, or compatible work consistent with the above	X
SUBDIVISIONS (EXCEPT FOR HISTORIC LANDMARKS OR THEORETICAL BUILDING SITES)	• Minor or insignificant lot changes compatible with the character of the property or its setting	X
	• Conversion of assessment and taxation lots to record lots	X
	• Subdivisions required to implement a rehabilitation or construction project approved by HPRB	X



EXCAVATION, SHEETING AND SHORING



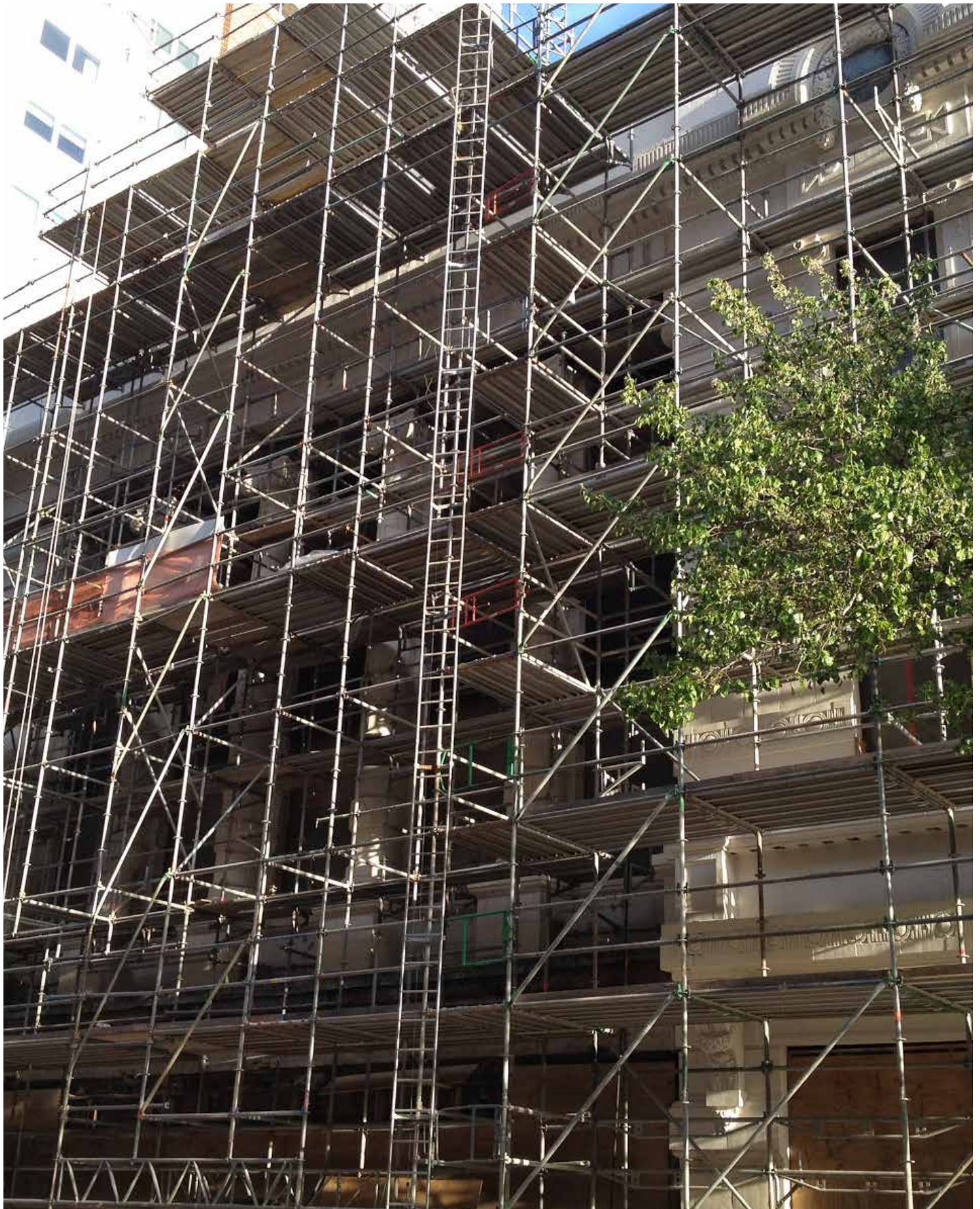

SCAFFOLDING IN PUBLIC SPACE



# V. DC BUILDING CODES AND CODE CONSIDERATIONS

The District of Columbia has construction and green building codes that establish required standards for building, site construction, and energy efficiency that increase in stringency every few years. Licensed architects, engineers and contractors performing building construction on behalf of a property owner should be aware of these codes and their requirements.

## Construction Codes:

- *INTERNATIONAL BUILDING CODE (IBC)*
- *INTERNATIONAL RESIDENTIAL CODE (IRC)*
- *INTERNATIONAL EXISTING BUILDING CODE (IEBC)*

## Green Building Codes:

- *DC ENERGY CODE*
  - » 2013 DC Energy Code consists of the 2012 International Energy Conservation Code with a District of Columbia supplement, and regulated the design and construction of buildings for the effective use and conservation of energy over the useful life of each building.
- *INTERNATIONAL GREEN CONSTRUCTION CODE (IgCC)*
  - » Intended to drive green building practices into every level of construction. IgCC is not a rating system, such as LEED® by USGBC, but is intended to be accepted as mandatory at a local jurisdiction level.
  - » Note that the IgCC provides multiple exceptions for historic properties, and most residential properties. Depending on the level of alteration, renovations may trigger additional mandatory upgrades targeted at high-energy using systems.

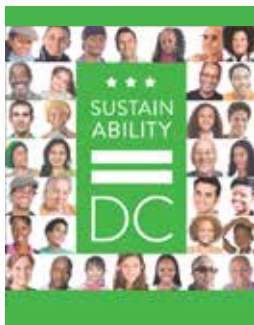

The District is currently formulating ambitious goals for regulating energy use within buildings. The aim is to make all buildings—both old and new—as energy efficient as possible. One area of focus is net zero energy. These targets—net zero energy and inclusion efficiency retrofits— elicit the following pragmatic questions:

- What are the building code-related challenges in achieving these energy targets?
- What resources are available to help navigate these technical challenges?
- How can existing buildings be put on the path toward being “net-zero energy ready” in anticipation of these requirements?

Some of the code considerations to be aware of when undertaking energy-efficiency retrofits include:

- Maintaining minimum required room size and ceiling heights when installing insulation;
- Requirements to reduce air leakage when undertaking renovation;
- Ensuring the structural integrity of a roof when installing solar or green roofs.

Some of the most common code considerations that should be taken into account when planning a green retrofit are discussed on the following pages.

## SUSTAINABLE DC

A DC-based initiative which intends for the District to be the healthiest, greenest, and most livable city in the United States in one generation. Sustainable DC sets high-performance goals for the city, including the following goals to be implemented by 2032:

- » Achieve a city-wide reduction in energy use and greenhouse gas emissions by 50%,
- » Increase the use of renewable energy so that it constitutes 50% of the city’s energy usage,
- » Meet net-zero energy standards for new construction and major renovation projects,
- » Decrease total water usage by 40%.



## INSULATING WALLS AND ATTICS

In Section III of this guideline, details are provided for improving the R value of exterior walls. However, these details do not account for one crucial code requirement: there are minimums for room sizes. All rooms must be a minimum of 7 feet in all plan dimensions per Section 1208.1 (2013 District of Columbia Building Code.) In Section 1208.3, the total square footage for a dwelling unit is prescribed to be a minimum of 120 square feet. In many older and historic buildings, there are small existing bedrooms. Prior to deciding to add exterior insulation to a small room, the Owner should create a plan diagram—with the proposed thicker walls—to verify that the code minimum requirements are maintained. If this study is not done and the room does not meet code, it will be flagged during the permit process.

Also included in this guide are details for insulating attics. Inserting enough insulation can be difficult where a sloped roof meets the back wall. If the Owner decides to lower the ceiling height to accommodate the insulation, the code minimums must be verified. Section 1208.2 prescribes the heights for various conditions; in every case, a seven-foot ceiling height must be maintained.

## AIR LEAKAGE

For the alteration of an existing building, the code uses the extent of the work as a means to establish if the current code standards must be met. For example, a Level Three Alteration is triggered by having the work area be greater than 50% of the building floor area. For single family residential buildings, this prompts the requirement for air leakage testing to confirm the addition has a minimum of 5 air changes per hour to satisfy the building code's requirement that all buildings have adequate ventilation. If it is determined that the addition has less than 5 air changes per hour from natural (passive) ventilation, then additional mechanical ventilation is required to meet the minimum prescribed by code.

## STRUCTURAL INTEGRITY OF A ROOF

Integrating sustainable technologies on the roof is one of the most viable options for many properties. However, as discussed in Section III, for many older and historic buildings, the structure of many roofs were not designed to handle more weight than the roof and calculated snow loads. A structural evaluation of the existing roof structure should be undertaken, and the structure supplemented as necessary, prior to the installation of solar arrays and green roofs.

## RESOURCES FOR NAVIGATING CODE QUESTIONS

The Department of Consumer and Regulatory Affairs (DCRA) and Historic Preservation Office (HPO) can assist in answering questions concerning the modifications to an existing or historic building.

## NET ZERO ENERGY “READY”

The push toward “Net Zero Energy Ready” is a concept that stems from a U.S. Department of Energy program intended to encourage single family home builders to take a forward-looking approach toward construction. This approach goes beyond modifying and upgrading the building envelope and the heating, cooling and ventilation systems to conserve energy. It includes considering what appliances are brought into the building; it addresses the air quality in a home; it offers a PV-ready checklist to facilitate future installation of solar panels; and finally, this program encourages building in such a way to mitigate the effect of regionally specific natural hazards.

Beyond Net Zero Energy Ready, the District encourages all new construction to be designed as Net Zero including solar installation at the time of construction. This can reduce the cost of the solar installation and ensure net zero from day 1.

<https://www.buildgreendc.org/laws-regs/>

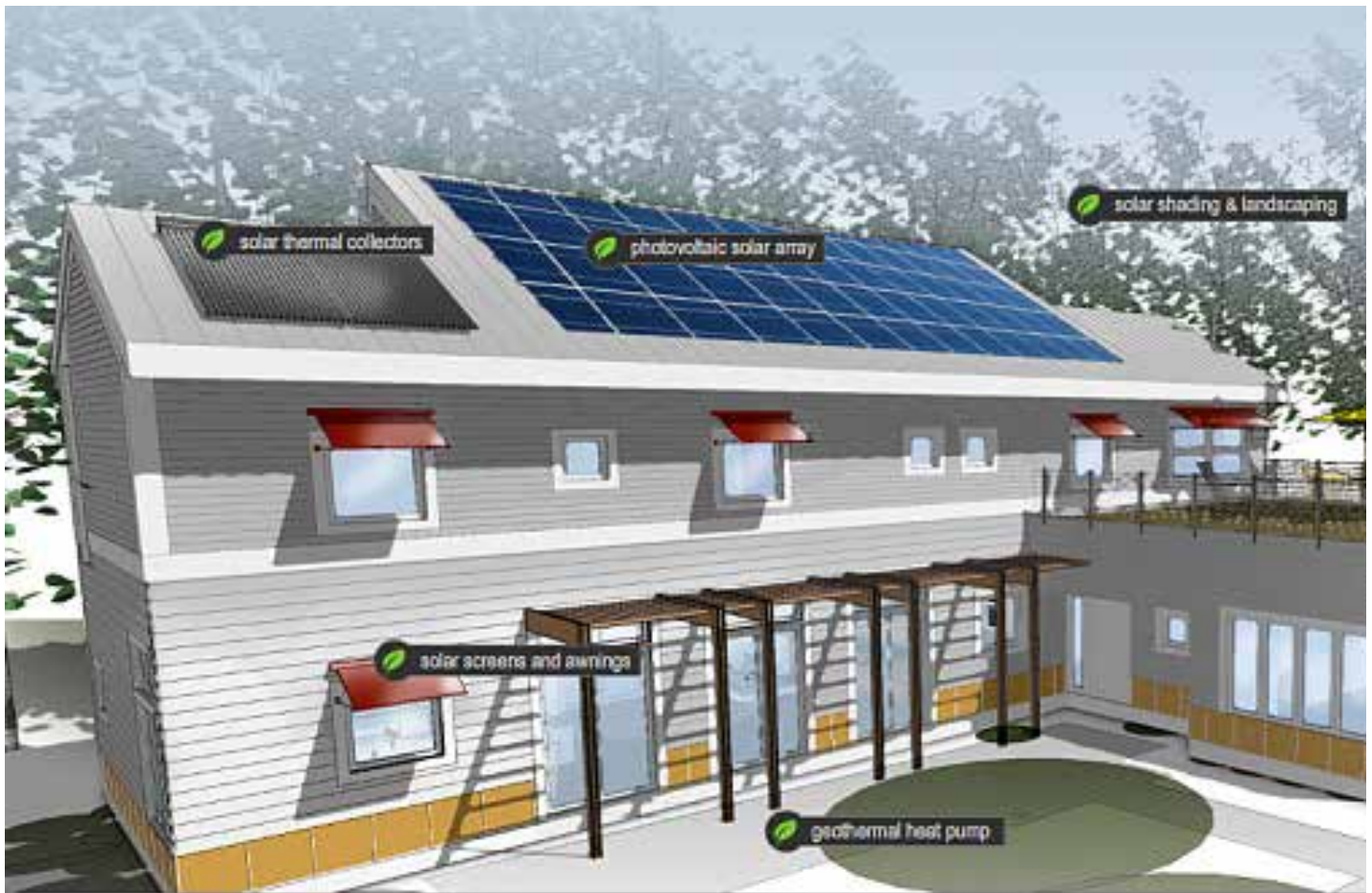

NET ZERO HOUSE

## VI. ADDITIONAL RESOURCES

### PLANNING

- **New Buildings Institute:** Provides building science research, technology assessments, building standards and tools for advanced efficiency measures and provides critical support for building owners, practitioners, utilities and jurisdictions that want to create or enhance programs that favor ultra-efficiency in buildings.  
<https://newbuildings.org/>
- **US Department of Energy, Home Energy Saver Energy Calculator:** provides a customized list of energy savings recommendations:  
<http://homeenergysaver.lbl.gov/consumer/>
- **Environmental Protection Agency (EPA), Target Finder Calculator:** online calculator that helps architects, engineers, and property owners and managers assess the energy performance of commercial building designs and existing buildings:  
<https://www.energystar.gov/buildings/service-providers/design/step-step-process/evaluate-target/epa%E2%80%99s-target-finder-calculator>
- **Green Building Advisor, Calculating Cooling Loads**  
<https://www.greenbuildingadvisor.com/article/calculating-cooling-loads>
- **DC Sustainable Energy Utility (DCSEU), Discounts and rebates on energy efficiency**  
<https://www.dcseu.com/homes>



## WALLS AND ROOFS

- **Cool Roofs**

- » U.S. Department of Energy (DOE) - “Guide to Cool Roofs”  
[https://www.energy.gov/sites/prod/files/guide\\_to\\_cool\\_roofs.pdf](https://www.energy.gov/sites/prod/files/guide_to_cool_roofs.pdf)

- **Weatherization**

- » D.C. Department of Energy & Environment (DOEE) Weatherization Field Guide & Assistance Program: Provides technical and financial assistance to help low-income residents reduce their energy bills by making their homes more energy efficient. Field guide provides best practices for installation of weatherization measures (note: not all guidance will be appropriate for historic resources)  
<https://doee.dc.gov/service/weatherization-assistance-program>
- » NPS Technical Preservation Services: Weatherization guide  
<https://www.nps.gov/TPS/sustainability/energy-efficiency/weatherization.htm>
- » EnergyStar: Seal and Insulate Guide  
[https://www.energystar.gov/index.cfm?c=home\\_sealing.hm\\_improvement\\_seal\\_insulate](https://www.energystar.gov/index.cfm?c=home_sealing.hm_improvement_seal_insulate)
- » DC HPO Walls and Foundations of Historic Buildings:  
<https://planning.dc.gov/page/design-guidelines>

- **Historic Preservation Maintenance and Repair Guidelines For Masonry**

<http://chrs.org/wp-content/uploads/2016/03/HPOmasonryBrief0316.pdf>

- **Roofs on Historic Buildings**

<https://planning.dc.gov/page/design-guidelines>

## WINDOWS AND DOORS

- **National Trust for Historic Preservation, “Saving Windows, Saving Money: Evaluating the Energy Performance of Window Retrofit and Replacement”**

<https://forum.savingplaces.org/connect/community-home/librarydocuments/viewdocument?DocumentKey=59eab0e4-f0f4-45c5-97c8-147a8def82ae&CommunityKey>

- **Window Repair and Replacement Preservation and Design Guidelines**

<https://planning.dc.gov/page/design-guidelines>

## LANDSCAPE AND SITE FEATURES

- **Green Roofs**

- » DOEE “Green Roofs in the District of Columbia” - information, tips, and resources  
<https://doee.dc.gov/greenroofs>
- » NPS, Technical Preservation Services, Interpreting the Standards Number 54: “Installing Green Roofs on Historic Buildings”  
<https://www.nps.gov/tps/standards/applying-rehabilitation/its-bulletins/ITS54-GreenRoofs.pdf>
- » NPS, Technical Preservation Services, “Green Roofs on Historic Buildings”, provides considerations for historic buildings, resources, and case studies  
<https://www.nps.gov/tps/sustainability/new-technology/green-roofs.htm>
- » Whole Building Design Guide - “Extensive Vegetative Roofs”, information on design and construction of green roofs  
<https://www.wbdg.org/resources/extensive-vegetative-roofs>
- » DOEE, Riversmart Rooftops Program, provides rebates for installation of green roofs within the District  
<https://doee.dc.gov/riversmart>

- **Stormwater Management and Green Infrastructure**

- » DOEE - Residential Stormwater and Flooding Information  
<https://doee.dc.gov/service/resources-residents>
- » DOEE - Green Area Ratio  
<https://doee.dc.gov/service/green-area-ratio-overview>
- » DDOT - Green Infrastructure  
<https://ddot.dc.gov/GreenInfrastructure>
- » Riversmart Homes:  
[doee.dc.gov/service/riversmart-homes-overview](https://doee.dc.gov/service/riversmart-homes-overview)

- **Landscaping, Landscape Features and Secondary Buildings in Historic Districts**

<https://planning.dc.gov/page/design-guideline>

- **Stormwater Management Guidebook**

<https://doee.dc.gov/swregs>

- **Rainwater Harvesting:**

<https://doee.dc.gov/sites/default/files/dc/sites/ddoe/publication/attachments/Section%203.3%20Rainwater%20Harvesting.pdf>

## SOLAR AND GREEN ROOF INSTALLATIONS

- **DCRA Solar Guidelines**  
<https://www.buildgreendc.org/solar/>
- **NPS, “Solar Panels on Historic Properties”**  
<https://www.nps.gov/tps/sustainability/new-technology/solar-on-historic.htm>
- **DOEE, Solar initiatives and resources**  
<https://doee.dc.gov/service/solar-initiatives>
- **DCRA Solar Permitting Guidelines:**  
<https://www.buildgreendc.org/s/Solar-Permit-Guidelines-20180815.pdf>
- **Energy.gov Solar Water Heaters:**  
<https://www.energy.gov/energysaver/water-heating/solar-water-heaters>
- **Active Solar Heating:**  
<https://www.energy.gov/energysaver/home-heating-systems/active-solar-heating>
- **Department of Energy, “Geothermal Heat Pump Basics”:**  
<https://www.energy.gov/energysaver/heat-and-cool/heat-pump-systems/geothermal-heat-pumps>

Additional information on GHP systems can be found here:

<https://planning.dc.gov/publication/geothermal-heat-pump-design-manual>



## INCENTIVES AND FUNDING SOURCES

- **DCRA Green Building Division**

<https://www.buildgreendc.org/incentives/>

- **DC PACE Financing**

<http://dcpace.com/>

» Property Assessed Clean Energy (PACE) is a financing tool in Washington, DC that allows property owners to repay the cost of energy efficiency, water and renewable energy improvements over time through a special assessment placed on the property.

- **DCSEU Discounts and Rebates for Residential**

<https://www.dcseu.com/homes>

» Homeowners: Energy Use, Appliances, Audits and Insulation, Heating and Cooling, Electronics and Lighting. Incentives, programs and tips on lowering your energy bill exist across these categories.

- **DCSEU Discounts and Rebates for Businesses**

<https://www.dcseu.com/commercial-and-multifamily>

» Business owners: Efficient Equipment, Affordable Housing and Benchmarking. Incentives, programs and tips exist across these categories.

- **Federal Residential Renewable Energy Tax Credit**

<https://www.energy.gov/savings/residential-renewable-energy-tax-credit>

- **DC Green Bank**

<https://dcgreenbank.org>

- **Solar Renewable Energy Credits (SRECs)**

<https://doee.dc.gov/service/solar-initiatives>

» DC has one of the shortest payback periods in country for solar PV due to the high value of locally generated SRECs.

## AGENCY RESOURCES

### **DC Office of Planning - Historic Preservation Office:**

<https://planning.dc.gov/page/historic-preservation-office>

### **DC Historic Preservation Design Guidelines:**

<https://planning.dc.gov/page/design-guidelines>

**DC Inventory of Historic Sites:**

<https://planning.dc.gov/page/historic-landmarks-and-historic-districts>

**DC Department of Energy & Environment (DOEE) Energy Assistance and Weatherization Resources:**

<https://doee.dc.gov/energyassistance>

**Renewable Energy Resources for Businesses:**

<https://doee.dc.gov/service/additional-renewable-energy-resources-businesses>

**DC Department of Consumer and Regulatory Affairs (DCRA):**

<https://dcra.dc.gov/>

**DCRA Green Building Division:**

<https://www.buildgreendc.org/>

**National Park Service**

- Technical Preservation Services, Sustainability:  
<https://www.nps.gov/tps/sustainability.htm>
- Energy Conserving Features Inherent in Older Homes:  
<https://www.nps.gov/tps/sustainability/greendocs/conservation-features-older-homes.pdf>
- The Secretary of the Interior's Standards for Rehabilitation & Illustrated Guidelines on Sustainability for Rehabilitating Historic Buildings:  
<https://www.nps.gov/tps/standards/rehabilitation/sustainability-guidelines.pdf>
- Preservation Briefs:  
<https://www.nps.gov/tps/how-to-preserve/briefs.htm>
  - » Brief 47 - Maintaining the Exterior of Small and Medium Size Historic Buildings
  - » Brief 3 - Improving Energy Efficiency in Historic Buildings
  - » Brief 4 - Roofing for Historic Buildings
  - » Brief 9 - Repair of Historic Wooden Windows
  - » Brief 13 - Repair and Thermal Upgrading of Historic Steel Windows
  - » Brief 24 - Heating, Ventilating, and Cooling Buildings: Problems and Recommended Approaches

## REPORT PREPARATION TEAMS

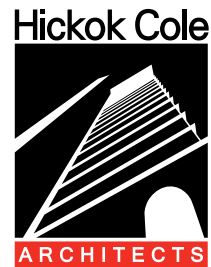

Published 2019

District of Columbia Office of Planning - Historic Preservation Office  
1100 4th Street SW, Suite E650  
Washington, DC 20024  
[www.preservation.dc.gov](http://www.preservation.dc.gov)  
(202) 442-8800

